

Skodawerke,  
Aktiengesellschaft in Pilsen.  
Waffenfabrik.



**7.5 cm**  
**m. 15 Gebirgskanone.**

Tafeln.



# Inhaltsverzeichnis des Bilderbandes.

## A. Bilder.

Tafel	1.	Rohr.
"	2.	Verschluß-Bestandteile.
"	3.	Verschluß (Ansicht von rechts vorne).
"	4.	Verschluß (Ansicht von rechts rückwärts).
"	5.	Geschütz (Ansicht von rechts rückwärts, Schutzschild und rechtes Rad abgenommen).
"	6.	Rohrmantel.
"	7.	Wiege (Ansicht von rechts vorne).
"	8.	Wiege (Ansicht von links rückwärts).
"	9.	Flüssigkeitsbremse (Ansicht von links rückwärts).
"	10.	Flüssigkeitsbremse (Ansicht von links vorne).
"	11.	Vorholvorrichtung.
"	12.	Rücklaufregulierung.
"	13.	Vorderlafette (Ansicht von links, Schutzschild und linkes Rad abgenommen).
"	14.	Antrieb der Höhenrichtmaschine.
"	15.	Schema der Richtmaschinen (Ansicht von rechts vorne).
"	16.	Ausgleichsvorrichtung.
"	17.	Antrieb der Seitenrichtmaschine.
"	18.	Schema der Richtmaschinen (Ansicht von links vorne).
"	19.	Geschütz (Ansicht von links rückwärts).
"	20.	Geschütz (Ansicht von rechts rückwärts, Schutzschild und Rohr abgenommen).
"	21.	Geschütz-Fernrohr und Notvisier.
"	22.	Geschütz-Richtkreis und Meßplatte.
"	23.	Geschütz-Richtkreis und Meßplatte.

- Tafel 24. Quadrant (Teilungsseite).
- " 25. Quadrant (Libellenseite).
- " 26. Munition.
- " 27. Patronenhülse und Pulverladungen.
- " 28. Munitionsverschlag.
- " 29. Munitionsverschlüge mit Munition.
- " 30. Geschütz samt Munitionsschild in Feuerstellung.
- " 31. Batterie-Richtkreis samt Stativ und Behälter.
- " 32. Batterie-Richtkreis.
- " 33. 15 jaches Doppelfernrohr samt Winkelspiegelrohr, Stativ und Behälter mit Beobachterschild.
- " 34. Entfernungsmesser samt Stativ und Behälter.
- " 35. Entfernungsmesser.
- " 36. Telephon-Handapparat und Leitungstasche.
- " 37. Telephon-Batterietasche und Signalgarnitur samt Behälter.
- " 38. Feldschmiede (gebrauchsfertig).
- " 39. Feldschmiede (halb zusammengelegt, Ansicht von unten).
- " 40. Feldschmiede (Ansicht von unten).
- " 41. Werkzeugkassette mit Amboss, beziehungsweise mit Schraubstock.
- " 42. Geschütz-Packsattel (Rohr-Packsattel).
- " 43. Munitions- und Bagage-Packsattel.
- " 44. Instrumenten-Packsattel.
- " 45. Vorderlafetten-Tragtier.
- " 46. Hinterlafetten-Tragtier (Räder abgenommen).
- " 47. Hinterlafetten-Tragtier.
- " 48. Wiegen-Tragtier.
- " 49. Rohrmantel-Tragtier.
- " 50. Rohr-Tragtier.
- " 51. Aufpackung der Gabeldeichsel.
- " 52. Lafettenschild-Tragtier.
- " 53. Munitionsschild-Tragtier.
- " 54. Munitions-Tragtier.
- " 55. Instrumenten-Tragtier (Ansicht von links).
- " 56. Instrumenten-Tragtier (Ansicht von rechts).
- " 57. Beobachterschild-Tragtier.

- Tafel 58. Telephon-Tragtier.
- " 59. Requisitenverschlag-Tragtier (Verschlage Nr. 1 und 2).
- " 60. Requisitenverschlag-Tragtier (Verschlage Nr. 3 und 4).
- " 61. Feldschmiede-Rassetten-Tragtier.
- " 62. Feldschmiede-Padtfaschen-Tragtier.
- " 63. Pionier- u. Schanzzeug-Tragtier (ohne Padtforbe).
- " 64. Pionier- und Schanzzeug-Tragtier (mit Padtforben).
- " 65. Pionier- und Schanzzeug-Tragtier (Padtladung zugedeckt).
- " 66. Richtmittelverschlag-Unterteil.
- " 67. Richtmittelverschlag-Unterteil (Aufsatz herausgenommen).
- " 68. Richtmittelverschlag-Oberteil.
- " 69. Requisitenverschlag Nr. 1.
- " 70. Requisitenverschlag Nr. 1 (Inhalt der Rassetten).
- " 71. Requisitenverschlag Nr. 2.
- " 72. Requisitenverschlag Nr. 2 (Behalter herausgenommen).
- " 73. Requisitenverschlag Nr. 3.
- " 74. Requisitenverschlag Nr. 4.
- " 75. Schlussel.
- " 76. Reserve-Schrauben, Muttern, Bolzen u. dgl.
- " 77. Schmiede-Werkzeug.
- " 78. Schmiede-Werkzeug.
- " 79. Feldschmiede-Padtfaschen und Werkzeug-Rassette.
- " 80. Beschlag-Werkzeug.
- " 81. Schlosser-Werkzeug.
- " 82. Wagner-Werkzeug.
- " 83. Sattler-Werkzeug.
- " 84. Vorderlasette mit Richtbaum.
- " 85. Einlegen der Wiege.
- " 86. Einlegen des Rohrmantels.
- " 87. Einlegen des Rohres.
- " 88. Geschuss, mit Gabeldeichsel fahrbar gemacht.
- " 89. Bespanntes Geschuss.

- Tafel 90. Nachfüllen der Flüssigkeitsbremse.  
" 91. Wiegenkappe geöffnet.  
" 92. Einbauen der Vorholfedern.

## B. Zeichnungen.

- Tafel 93. Verschuß.  
" 94. Rohr und Wiege.  
" 95. Rücklaufregulierung.  
" 96. Flüssigkeitsbremse.  
Schema des Aufsatzes.  
Schema des Batterierichtkreises.  
" 97. Aufsatz.  
" 98. 75 cm M. 15/8 Schrapnell.  
" 99. 75 cm M. 15/15 a Granate.  
" 100. 75 cm M. 15 Patronenhülse.

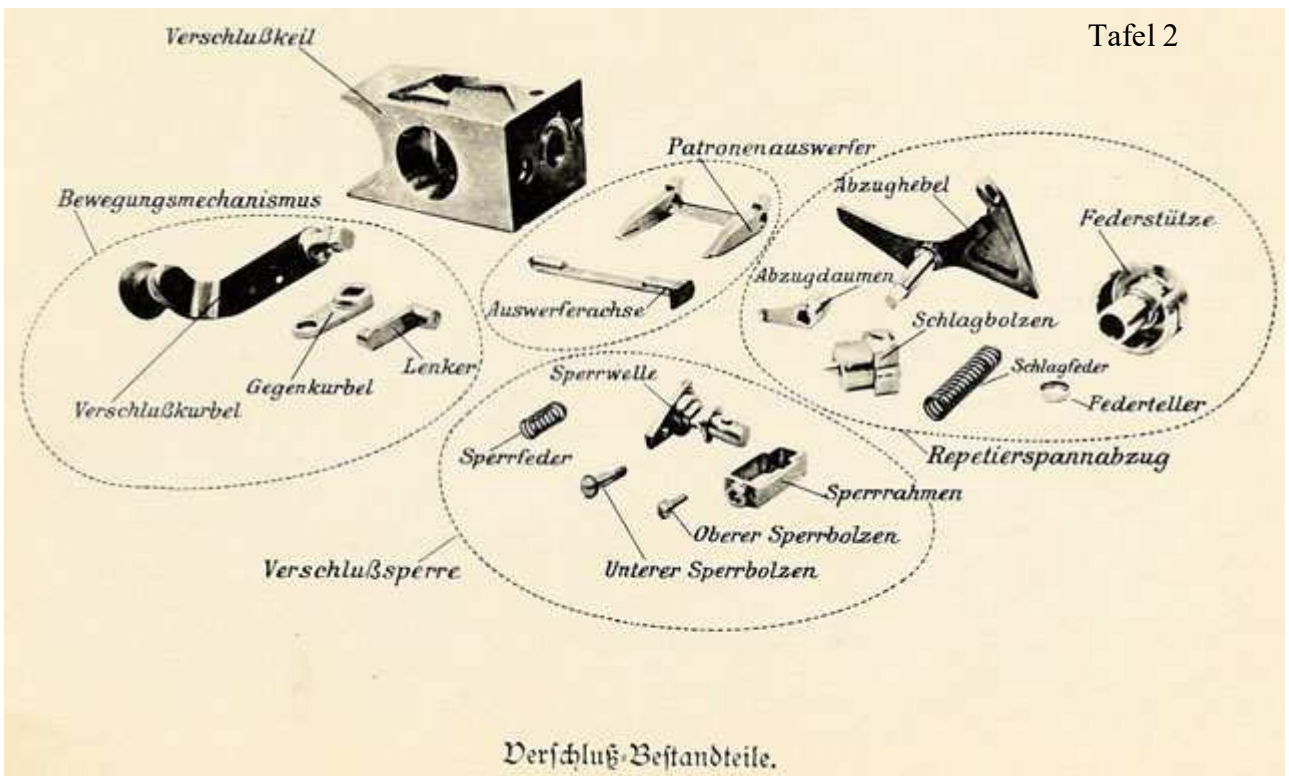
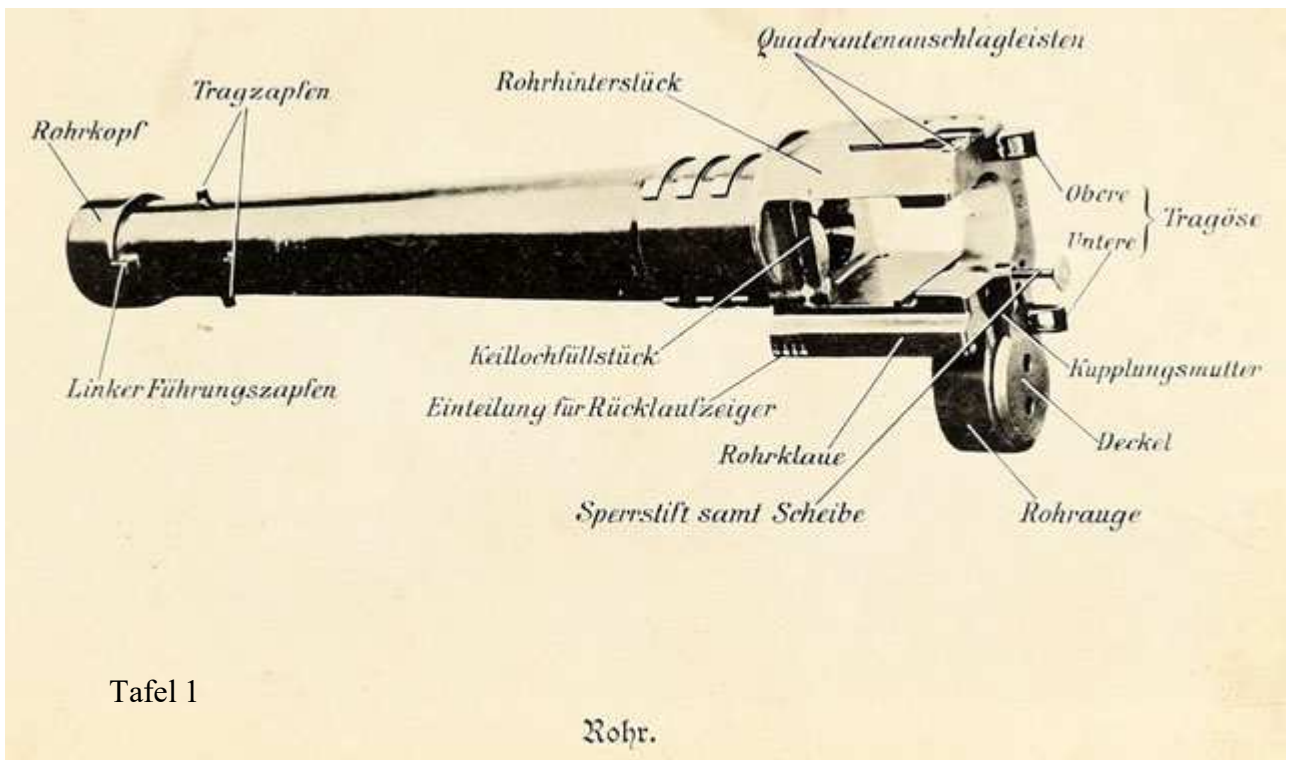

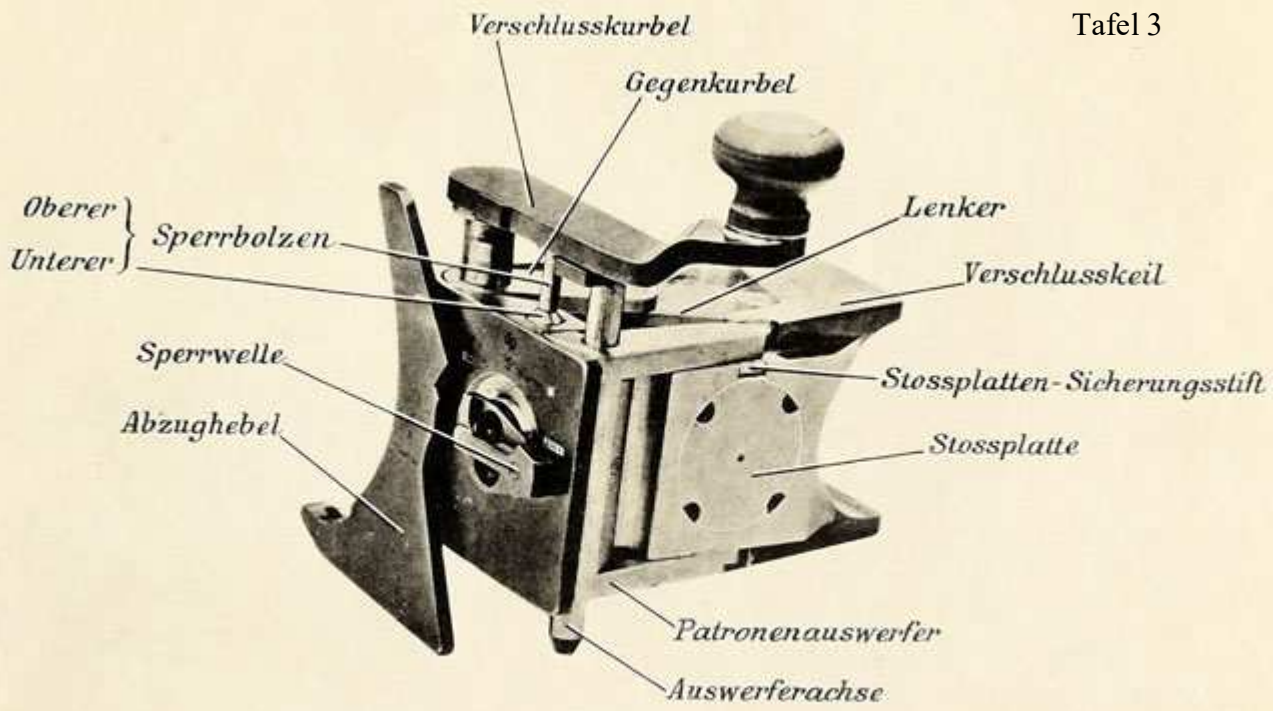

Verschluss (Ansicht von rechts vorne).

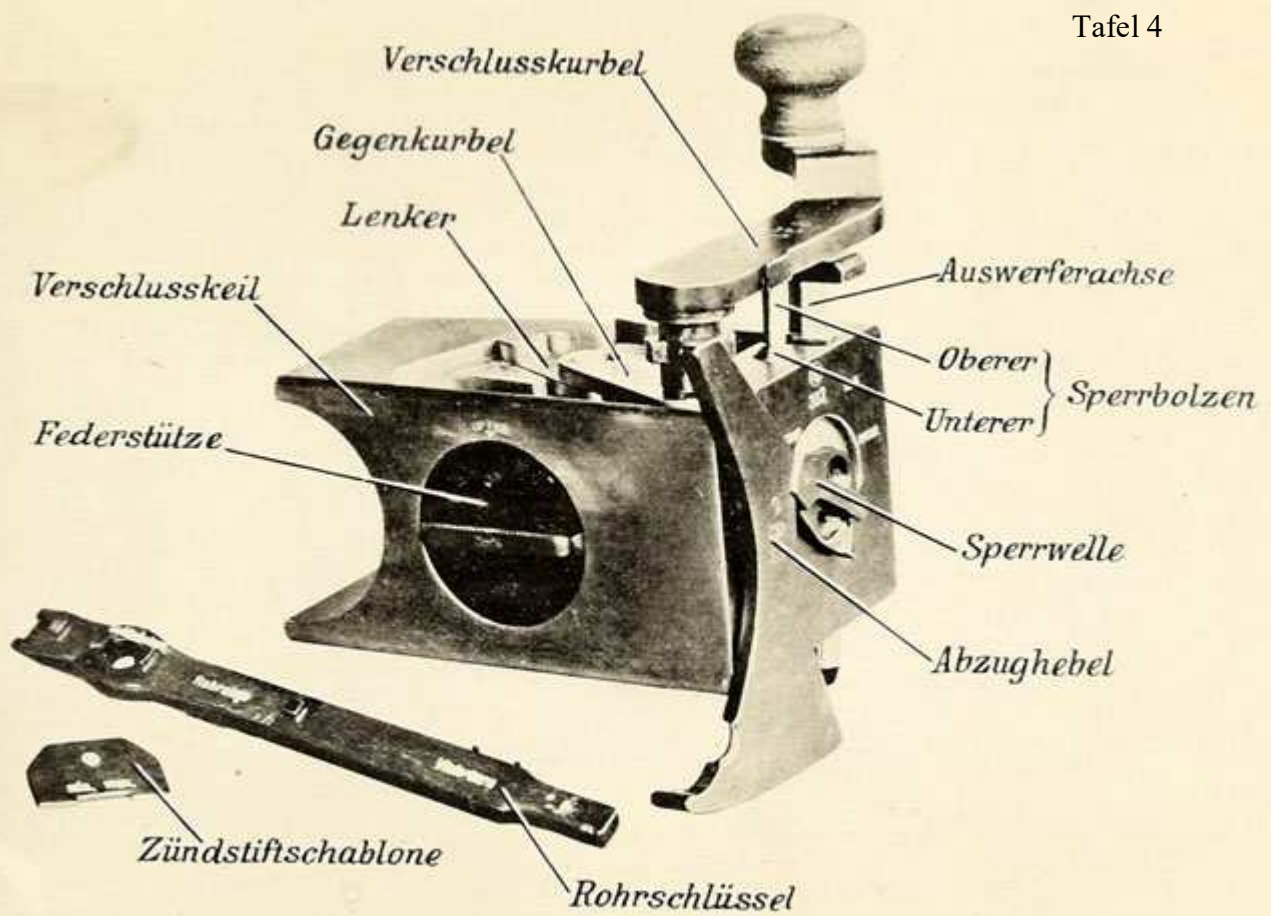

Verschluss (Ansicht von rechts rückwärts).





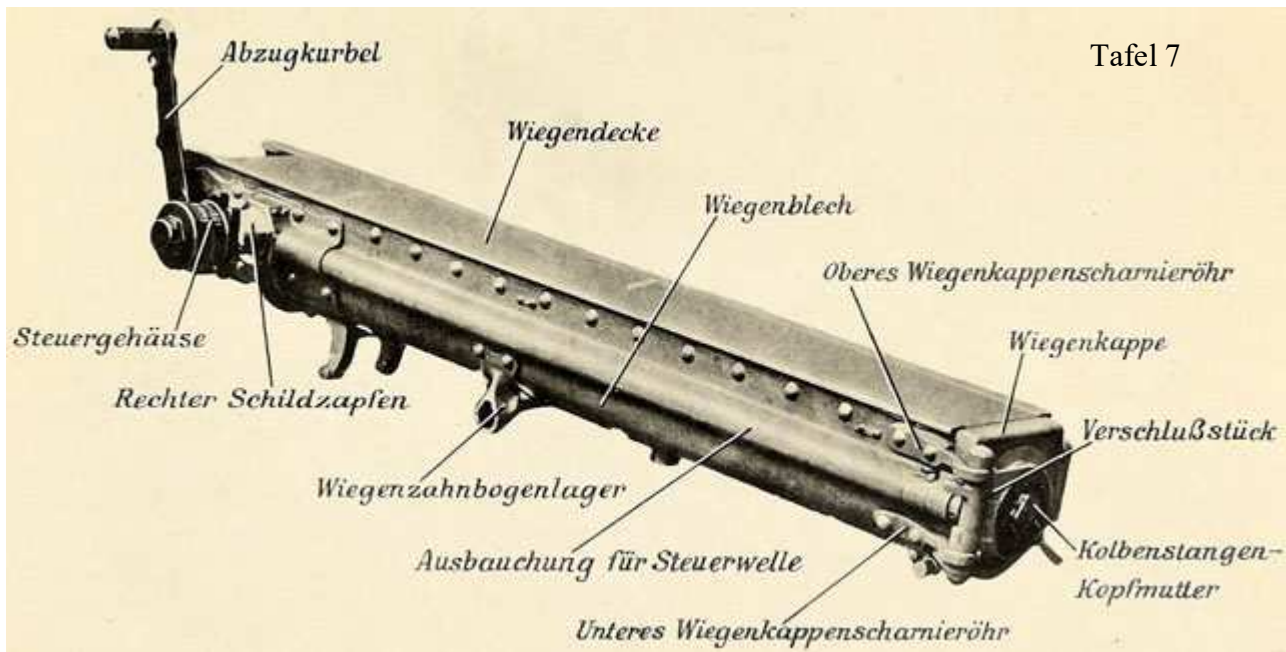
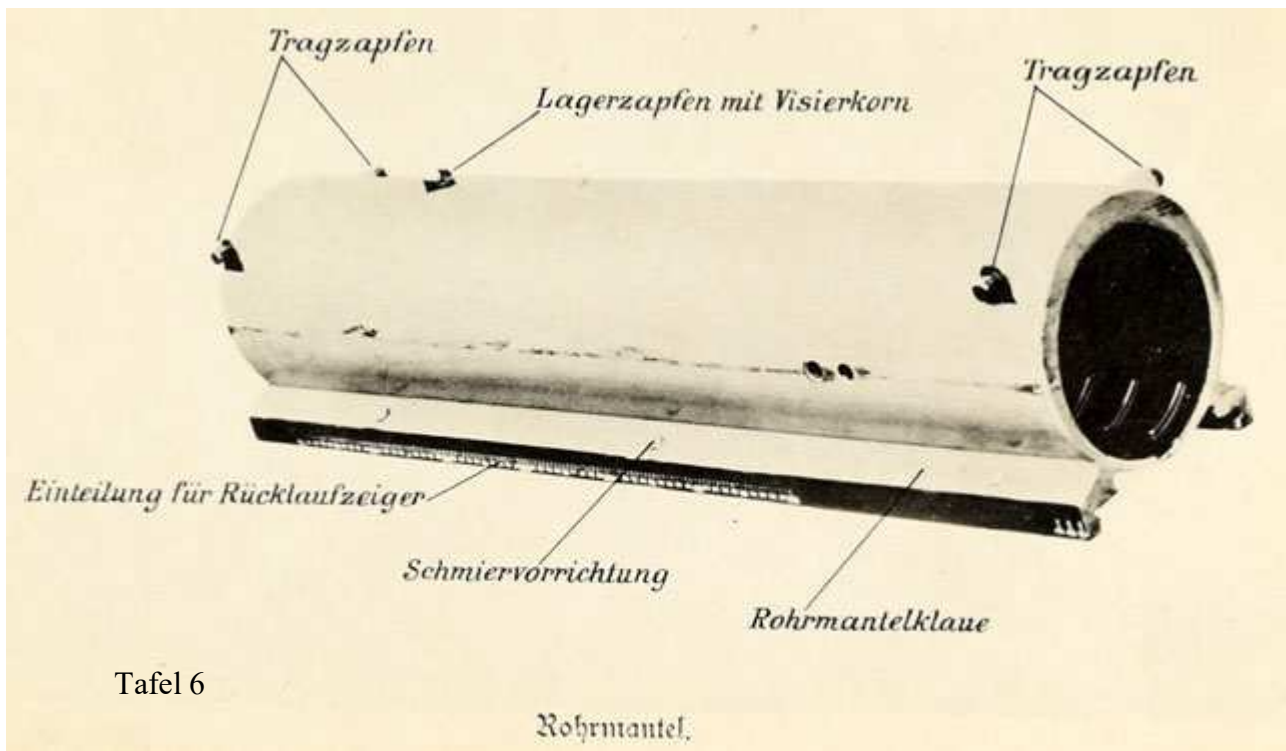

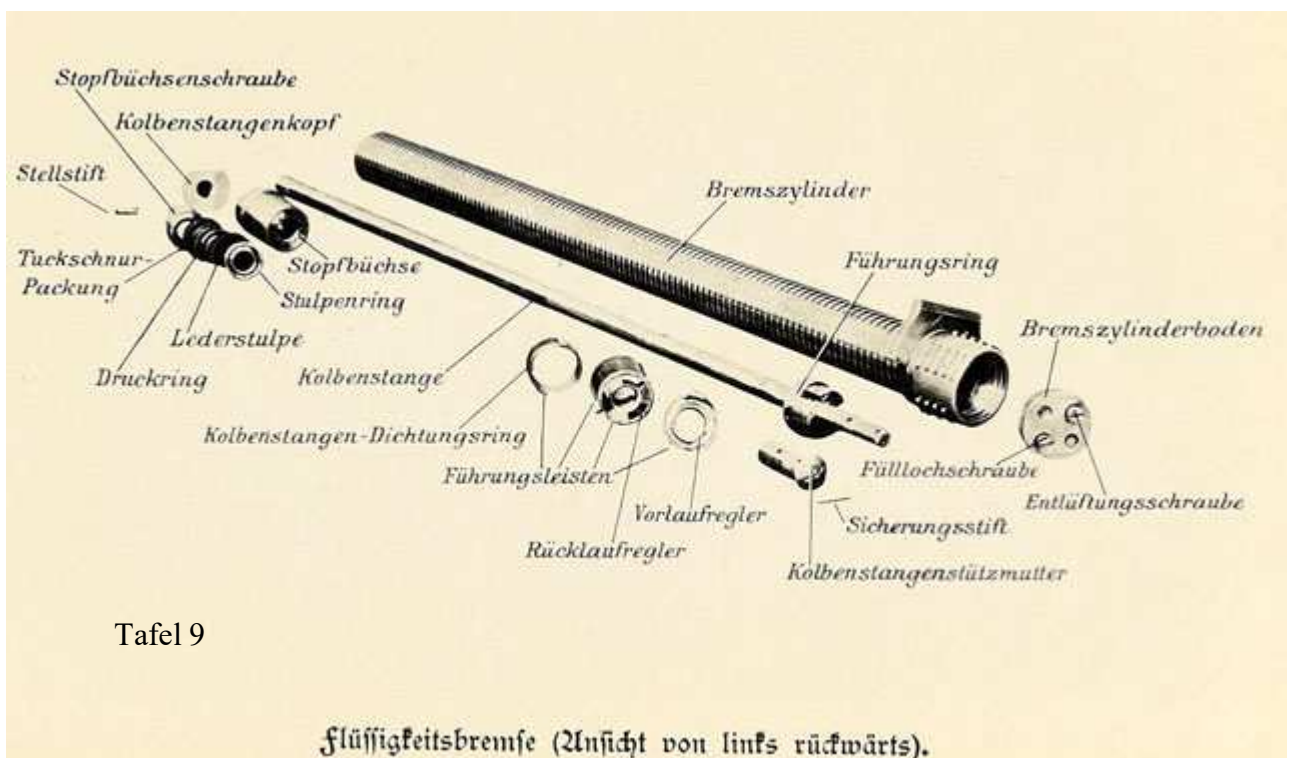
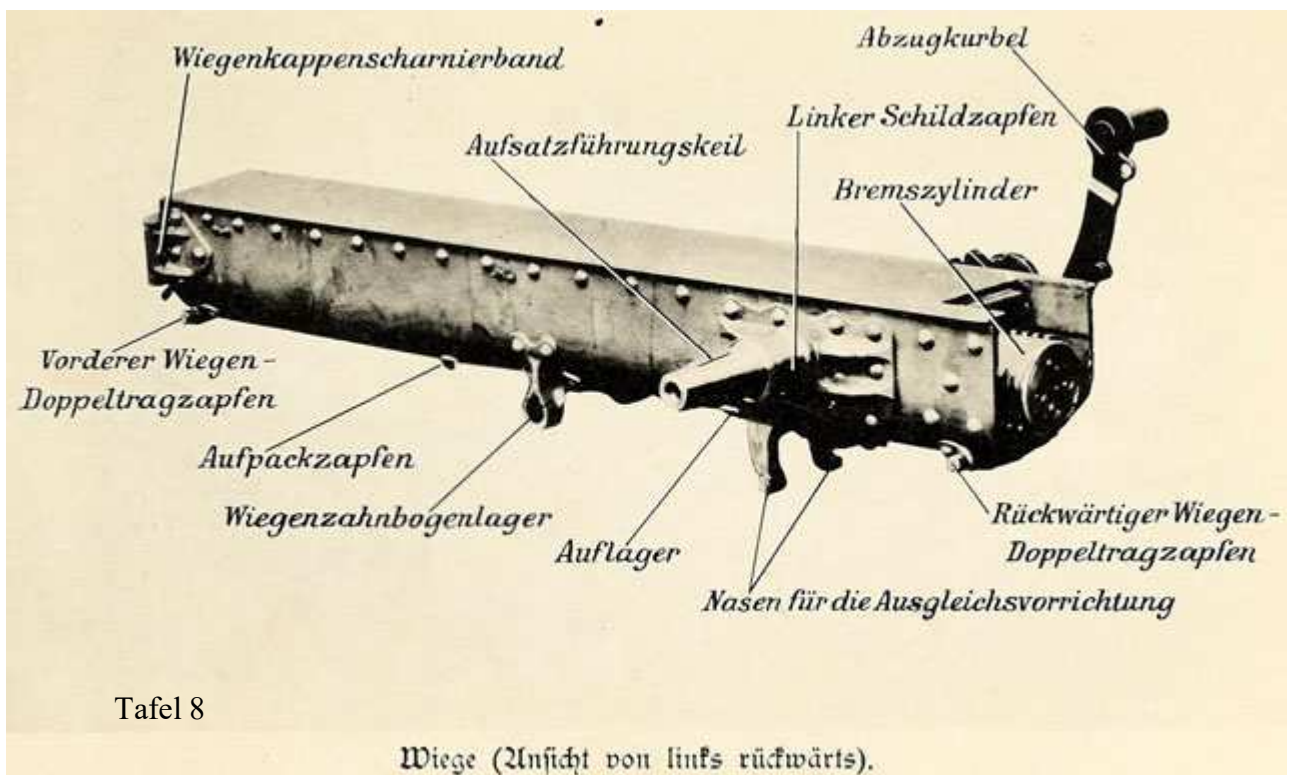

Tafel 10

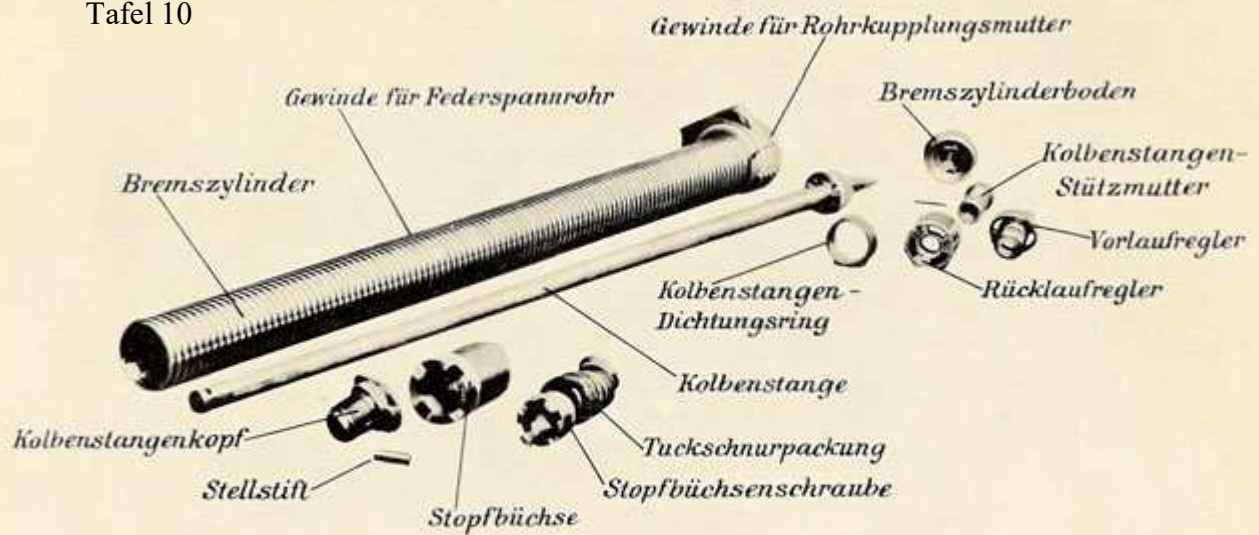

Flüssigkeitsbremse (Ansicht von links vorne).

Tafel 11

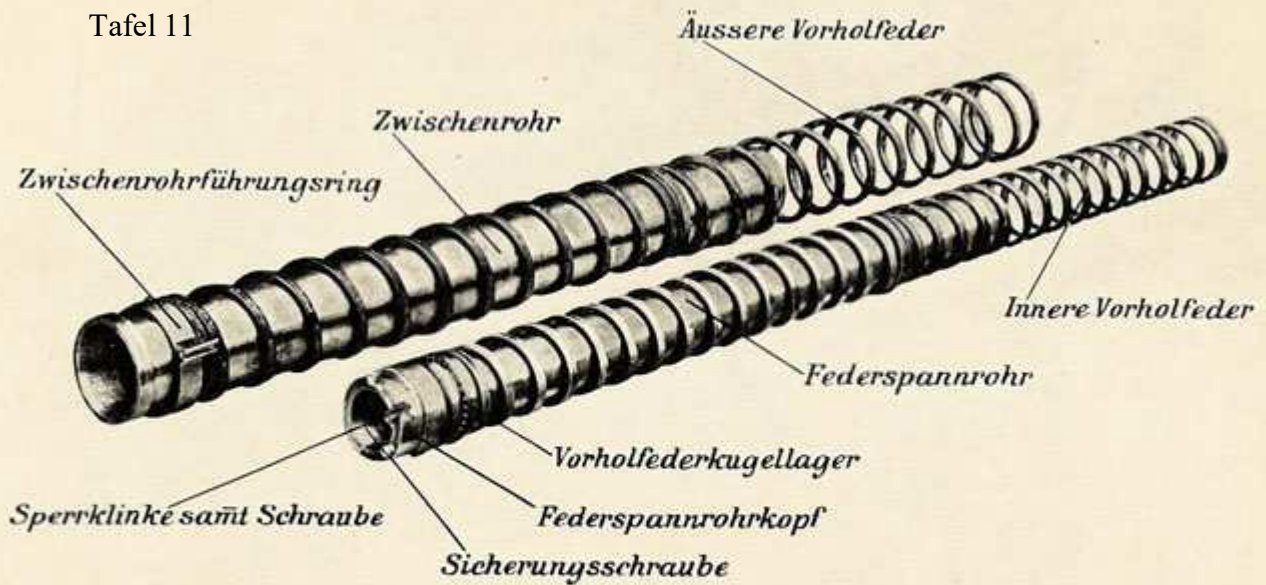

Vorholvorrichtung.

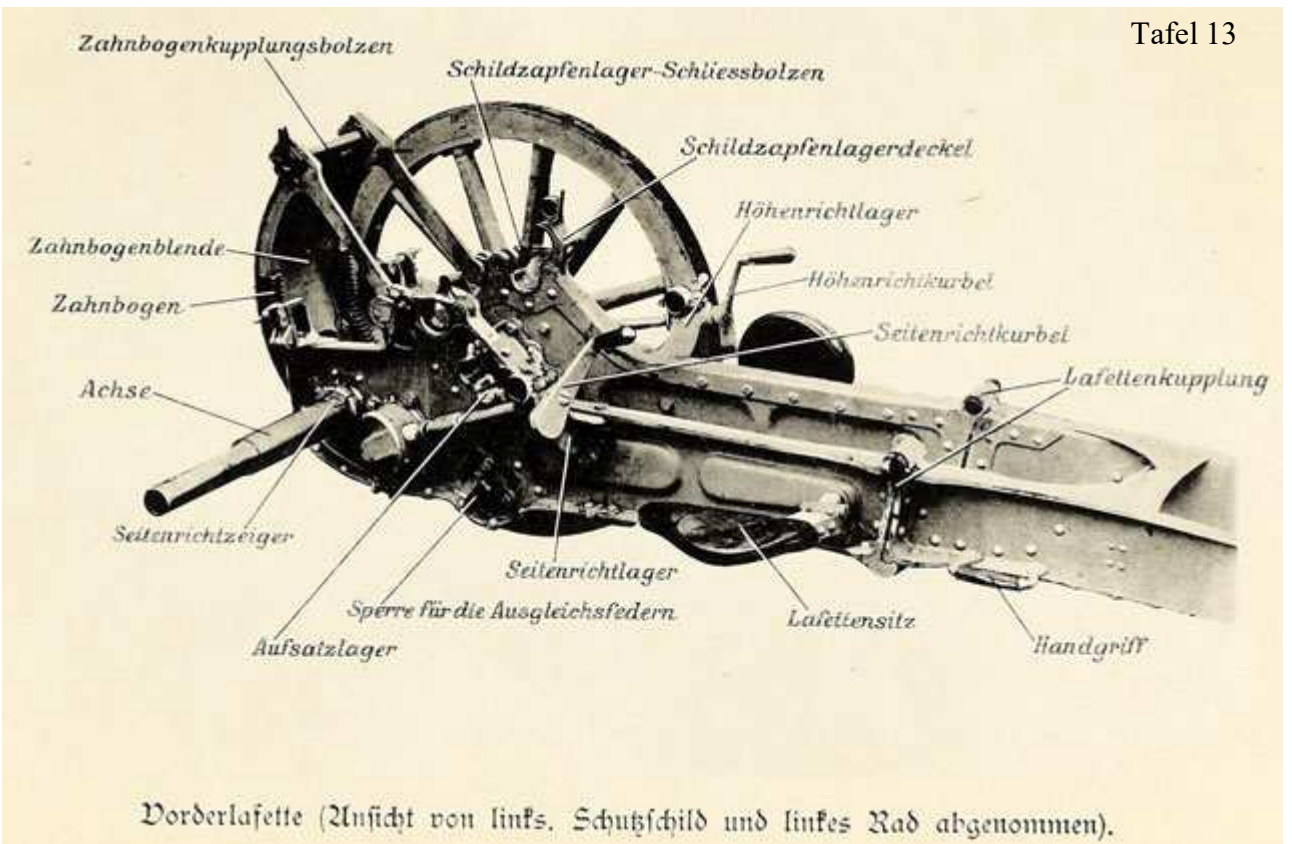
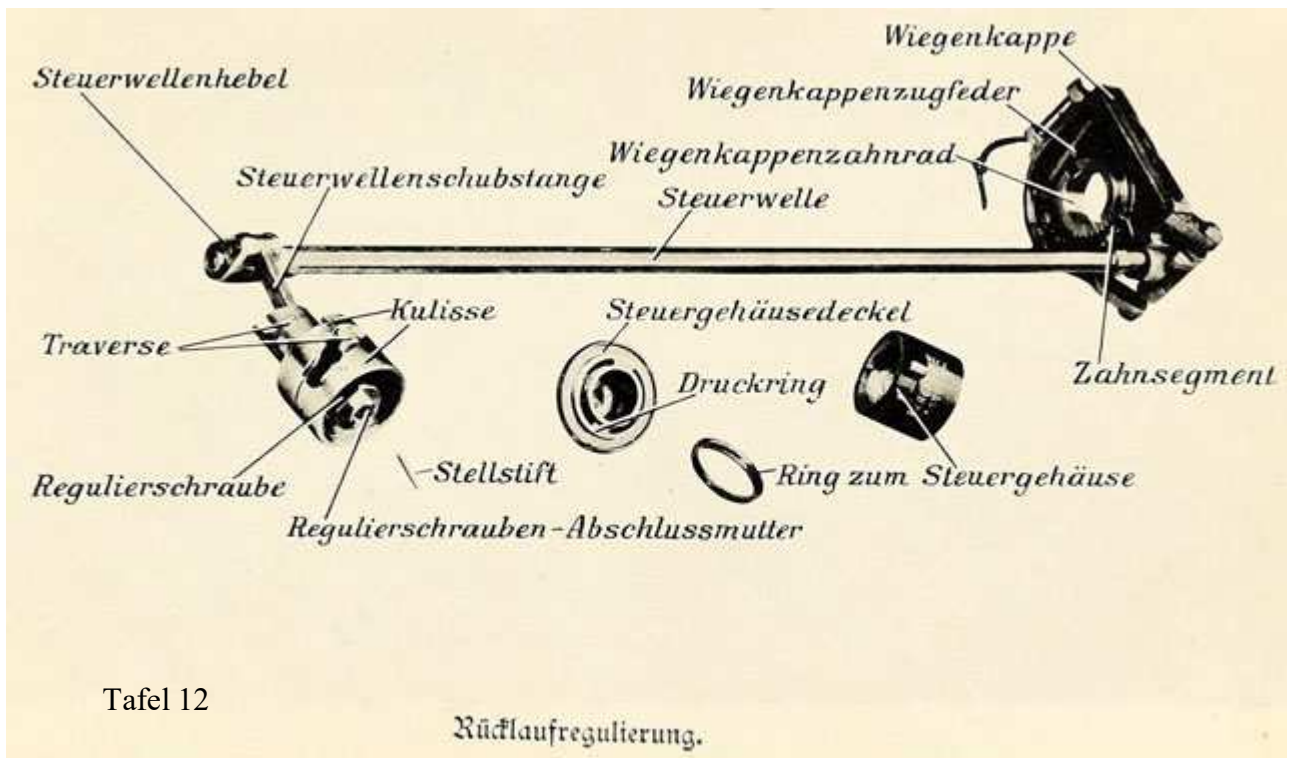

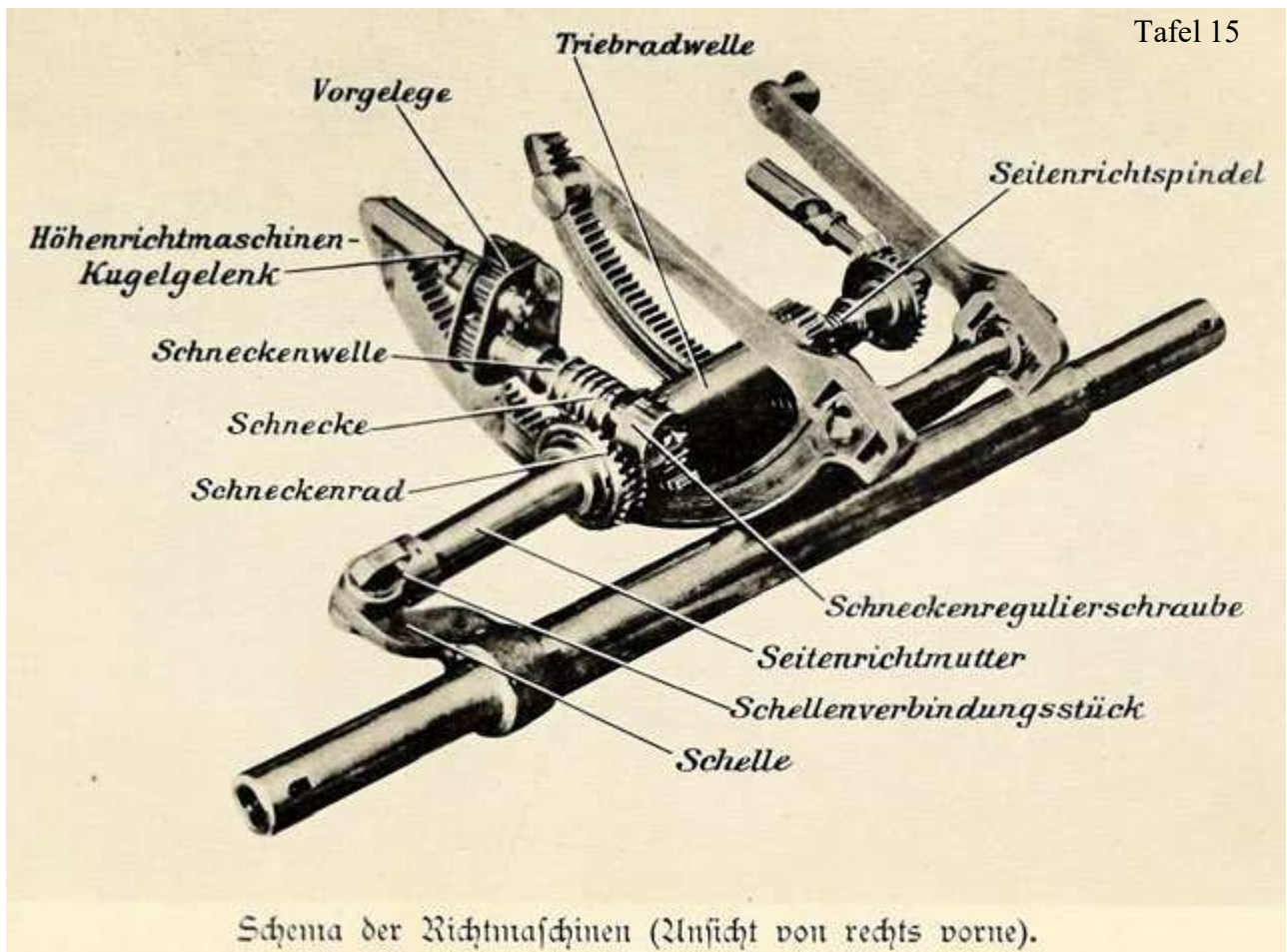
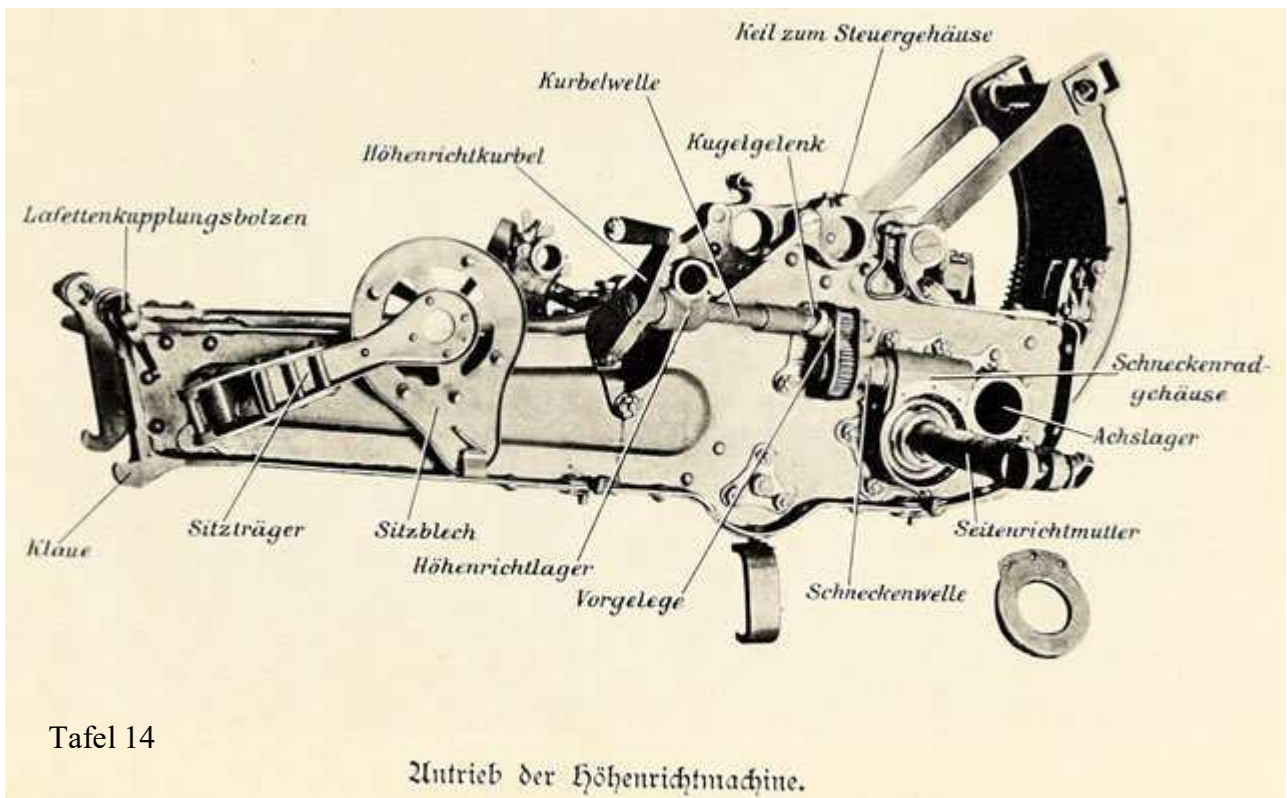

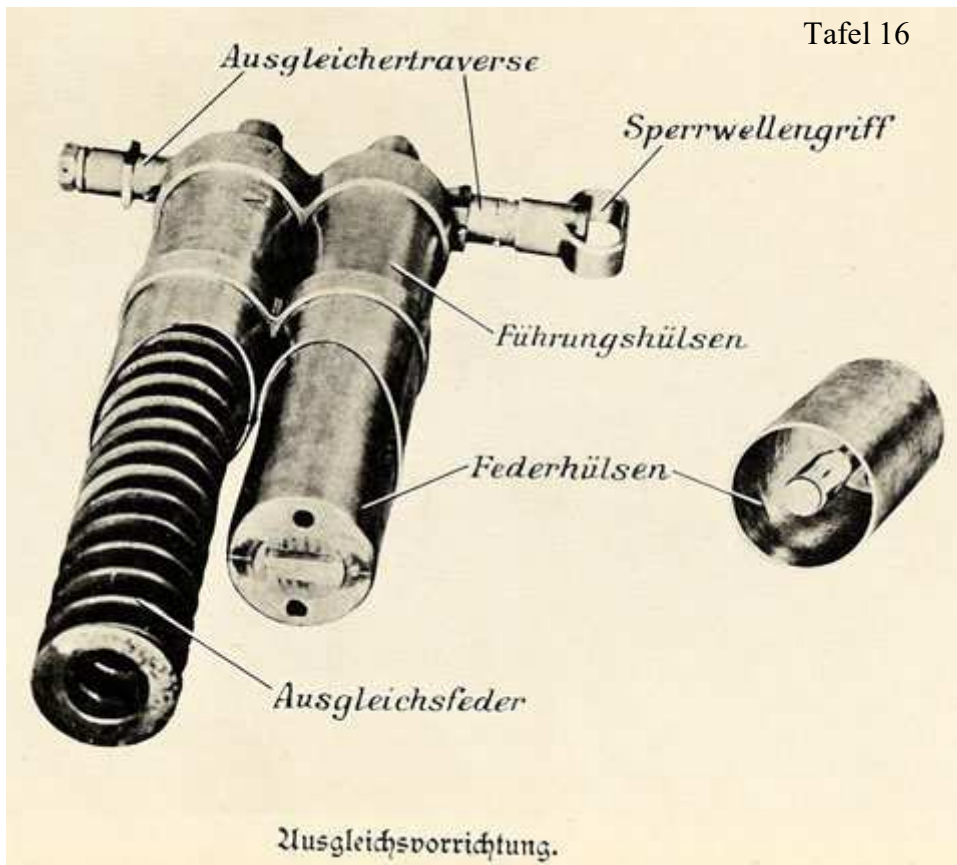

Tafel 17

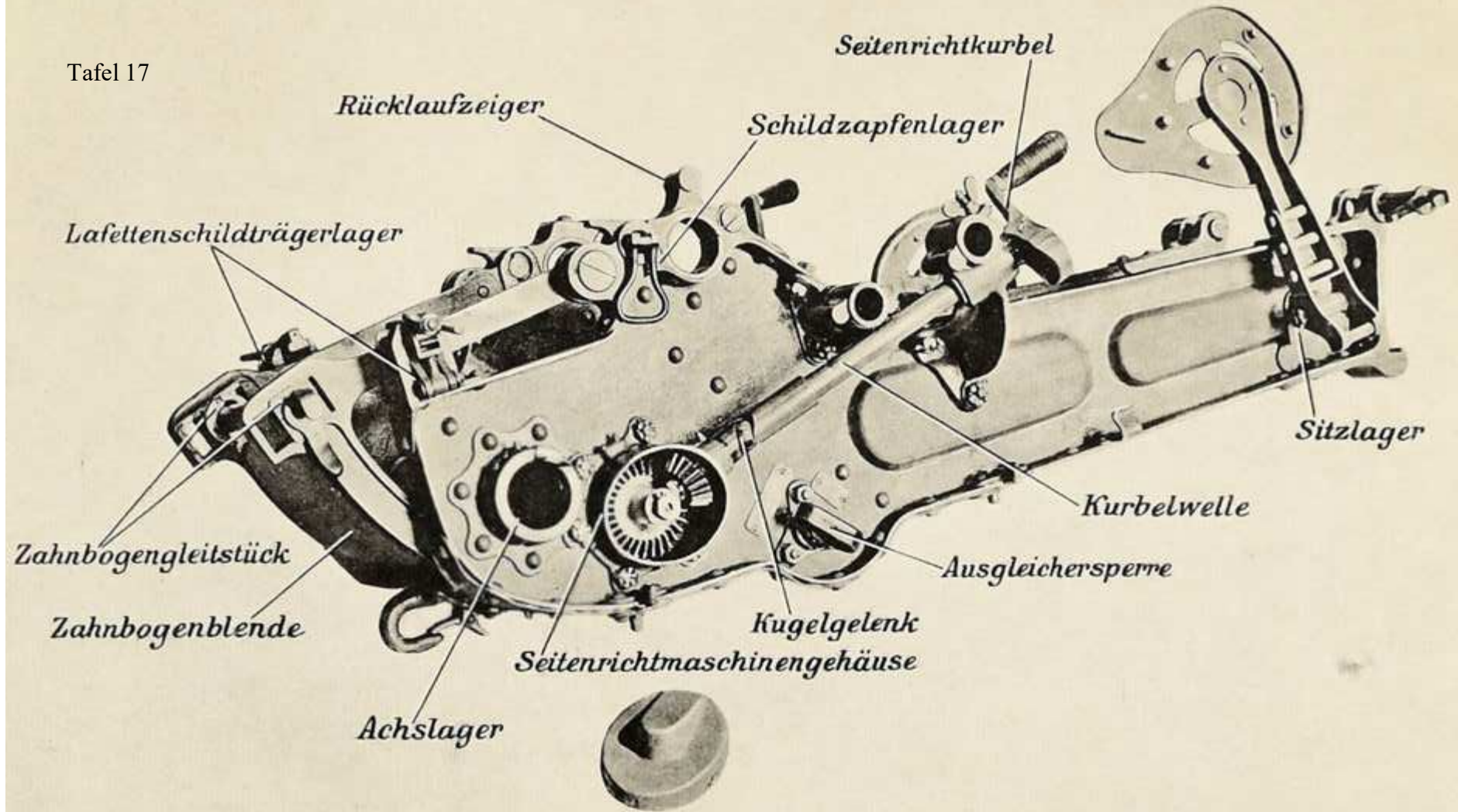

Antrieb der Seitenrichtmaschine.

Tafel 18

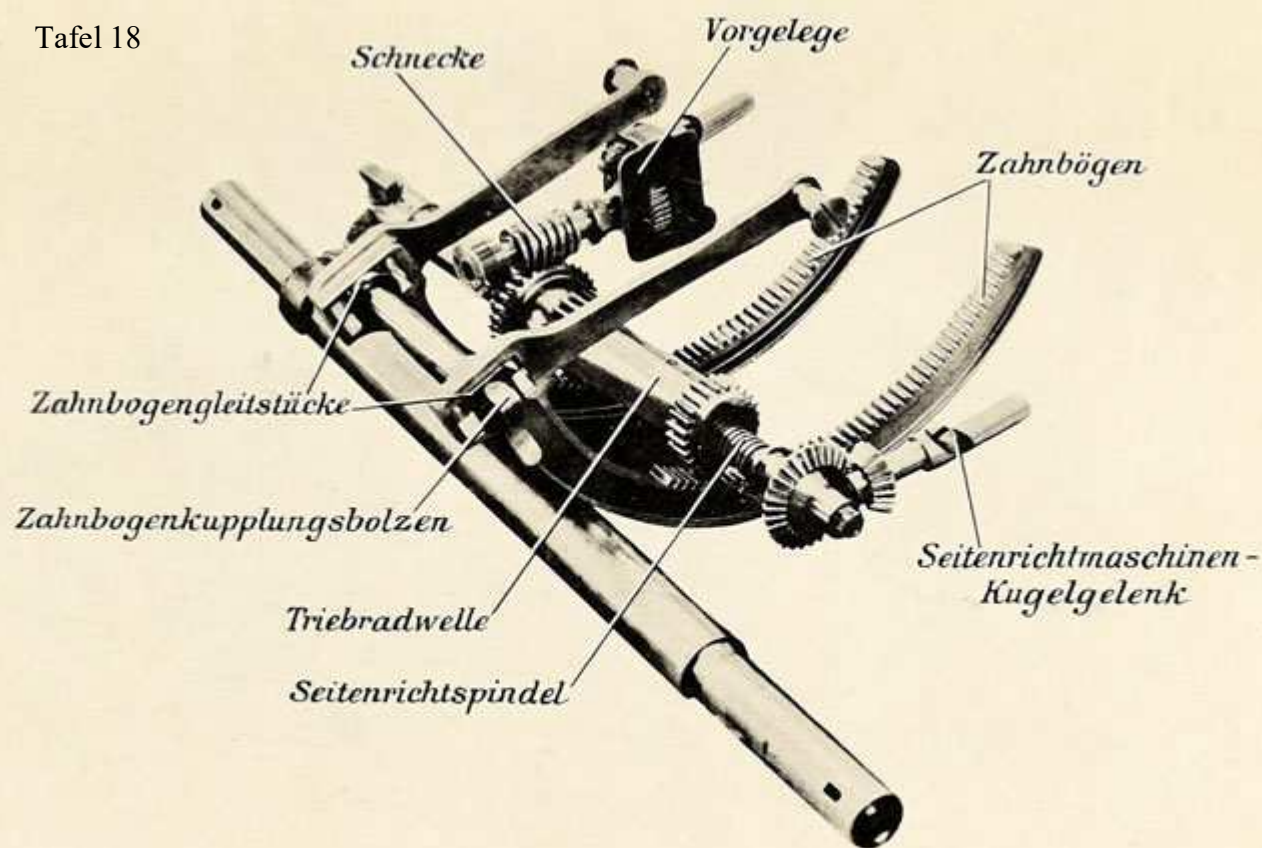

Schema der Richtmaschinen (Ansicht von links vorne).



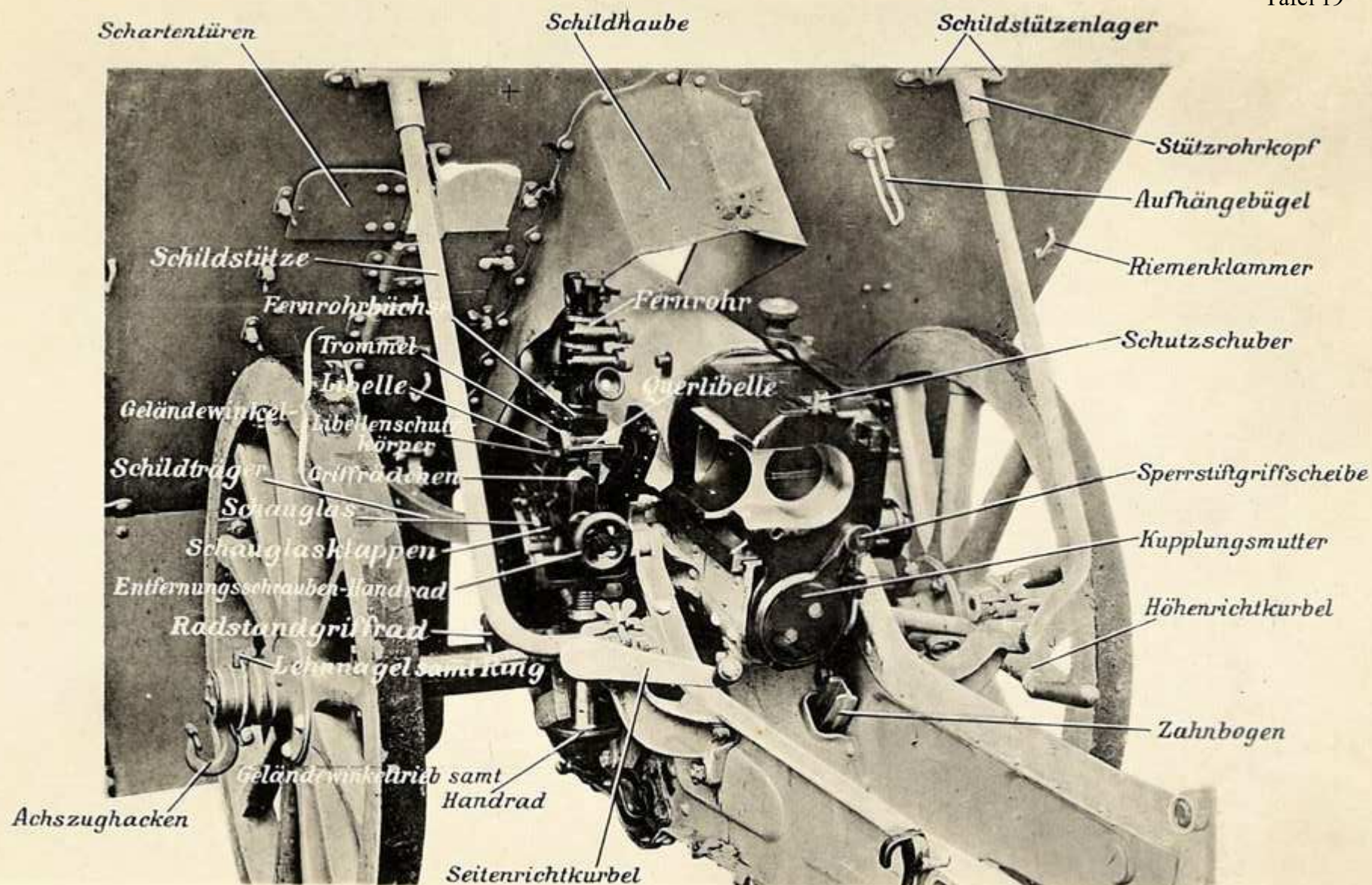

Geschütz (Ansicht von links rückwärts).

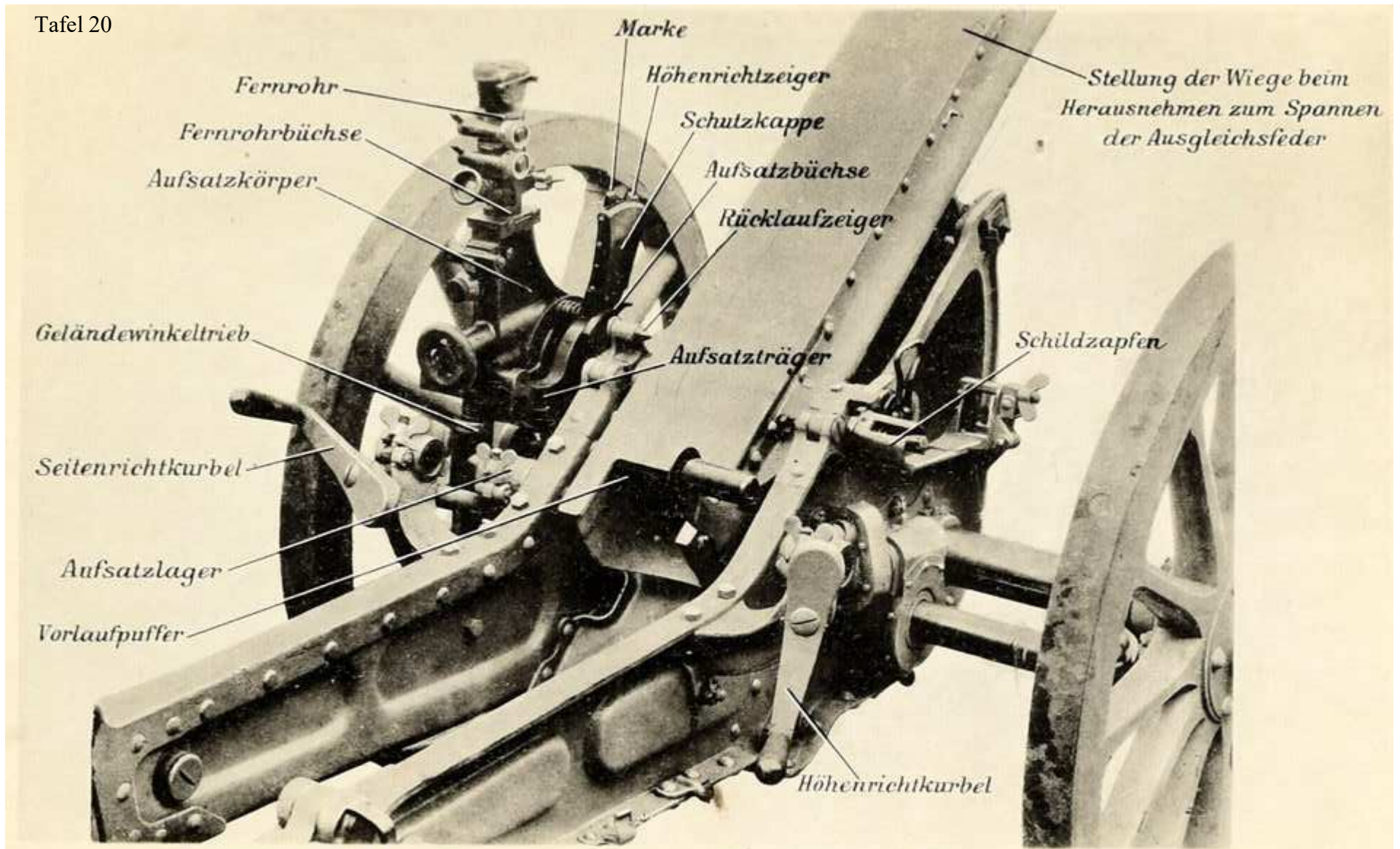

Geschütz (Ansicht von rechts rückwärts, Schutzschild und Rohr abgenommen).

Tafel 21

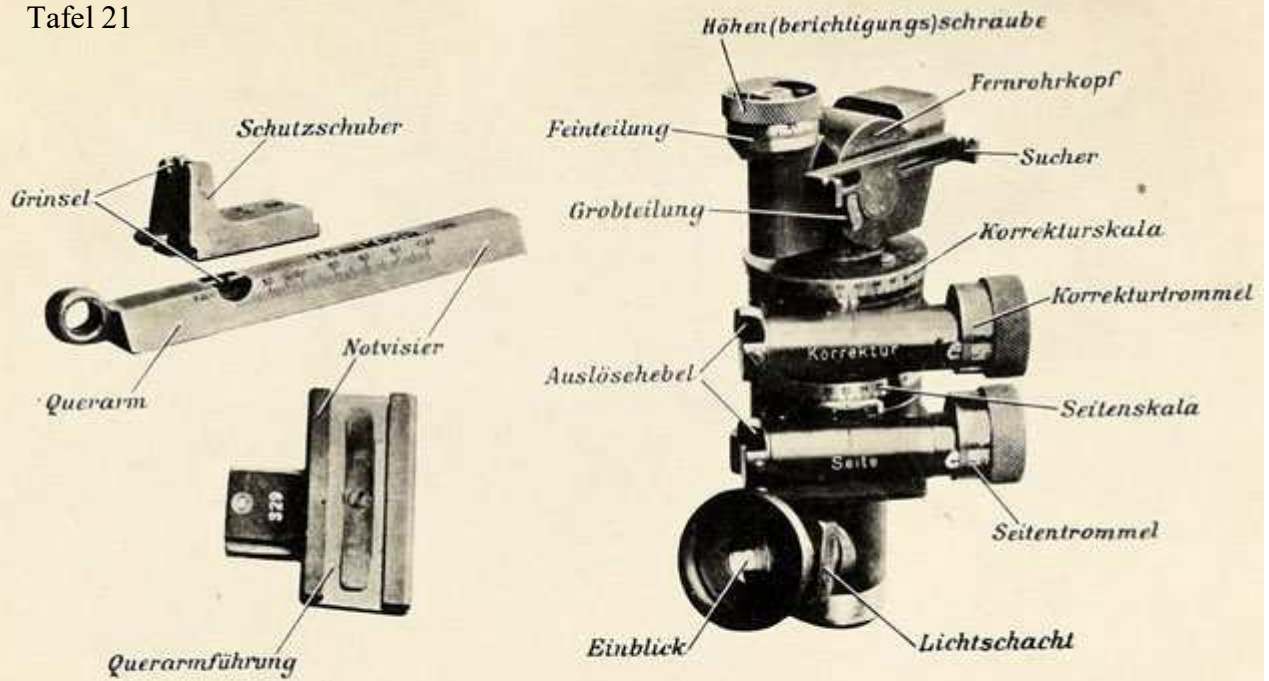

Geschützfernrohr und Notvisier.

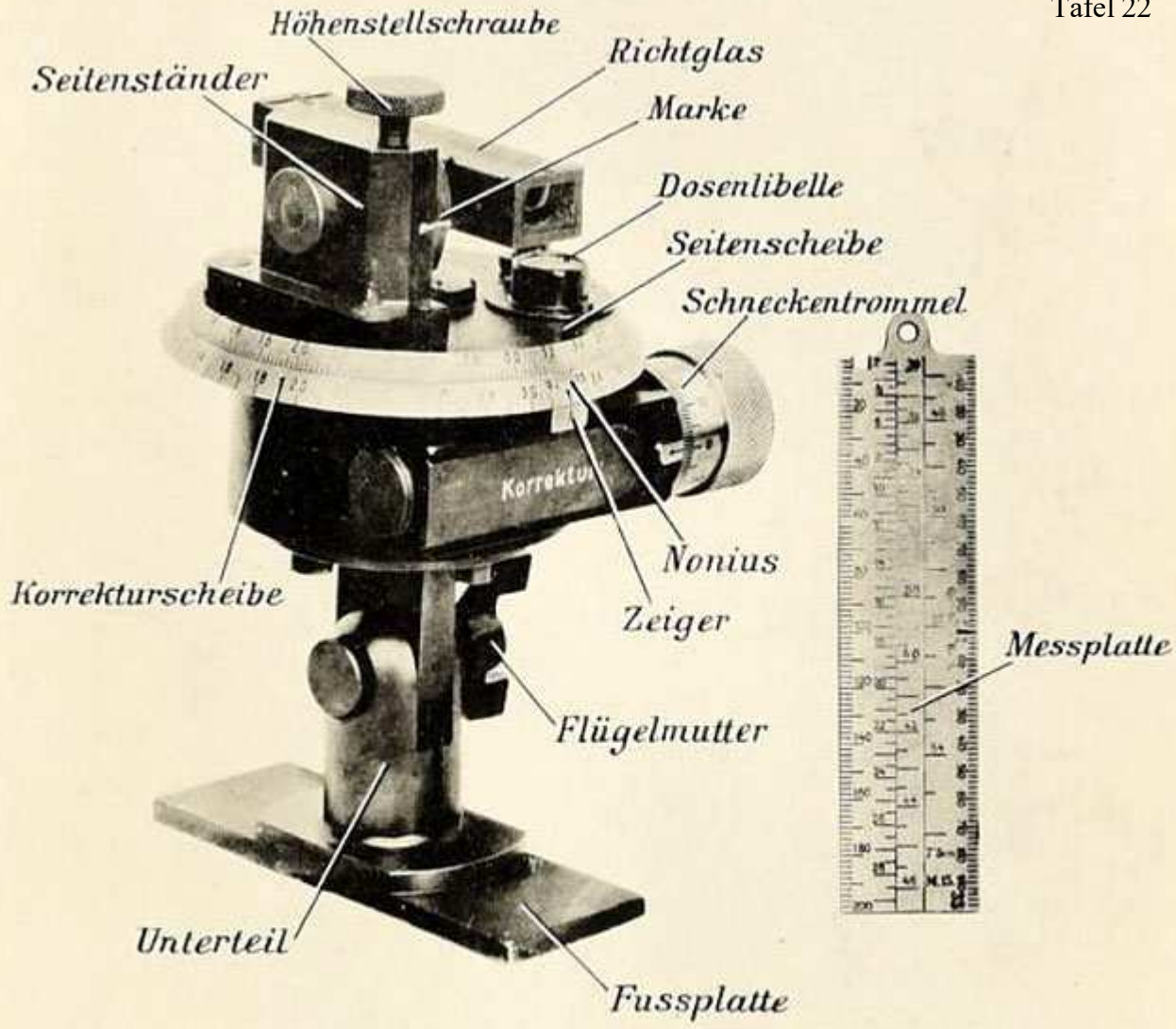

Geschütz-Richtkreis und Messplatte.

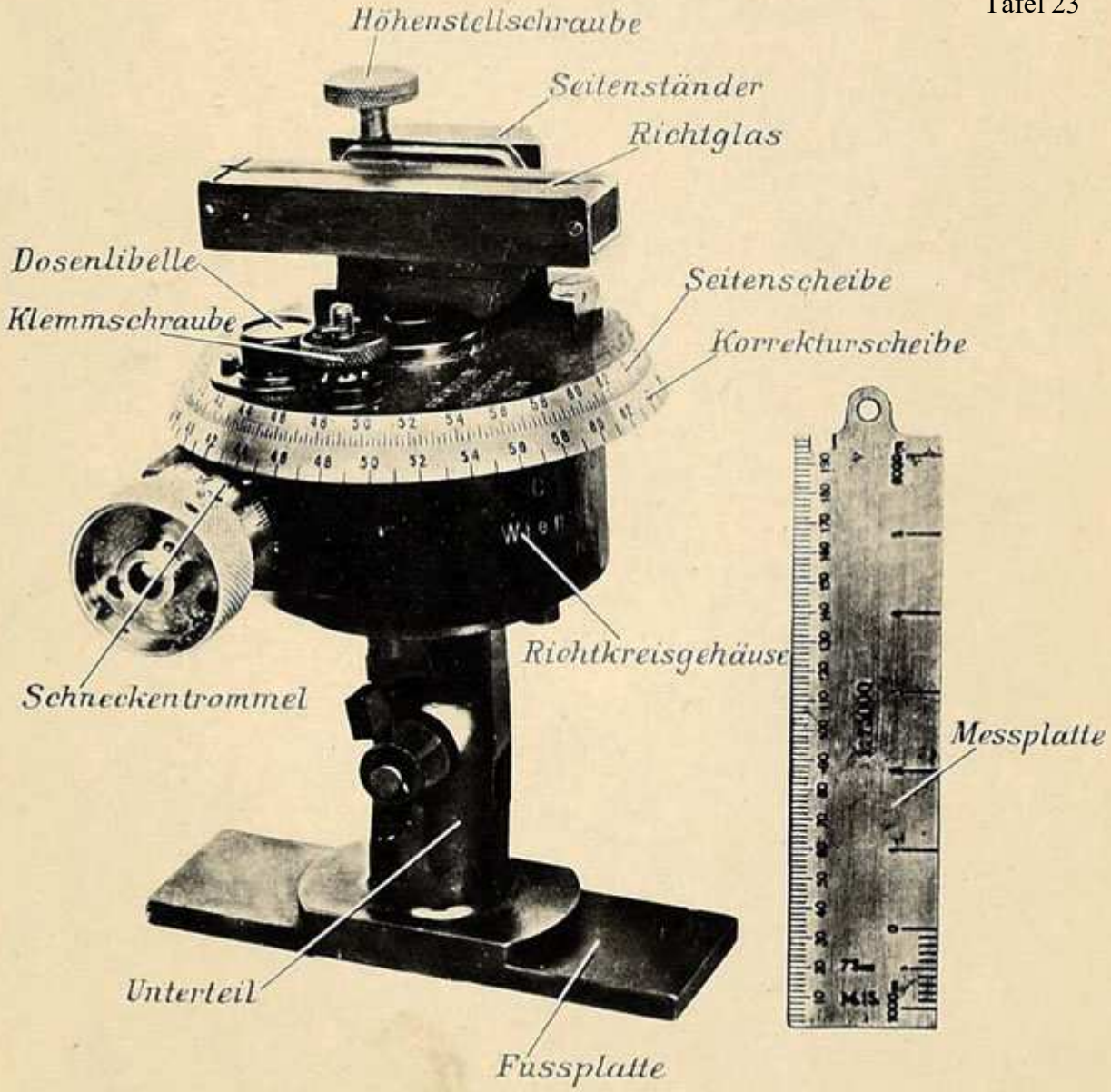

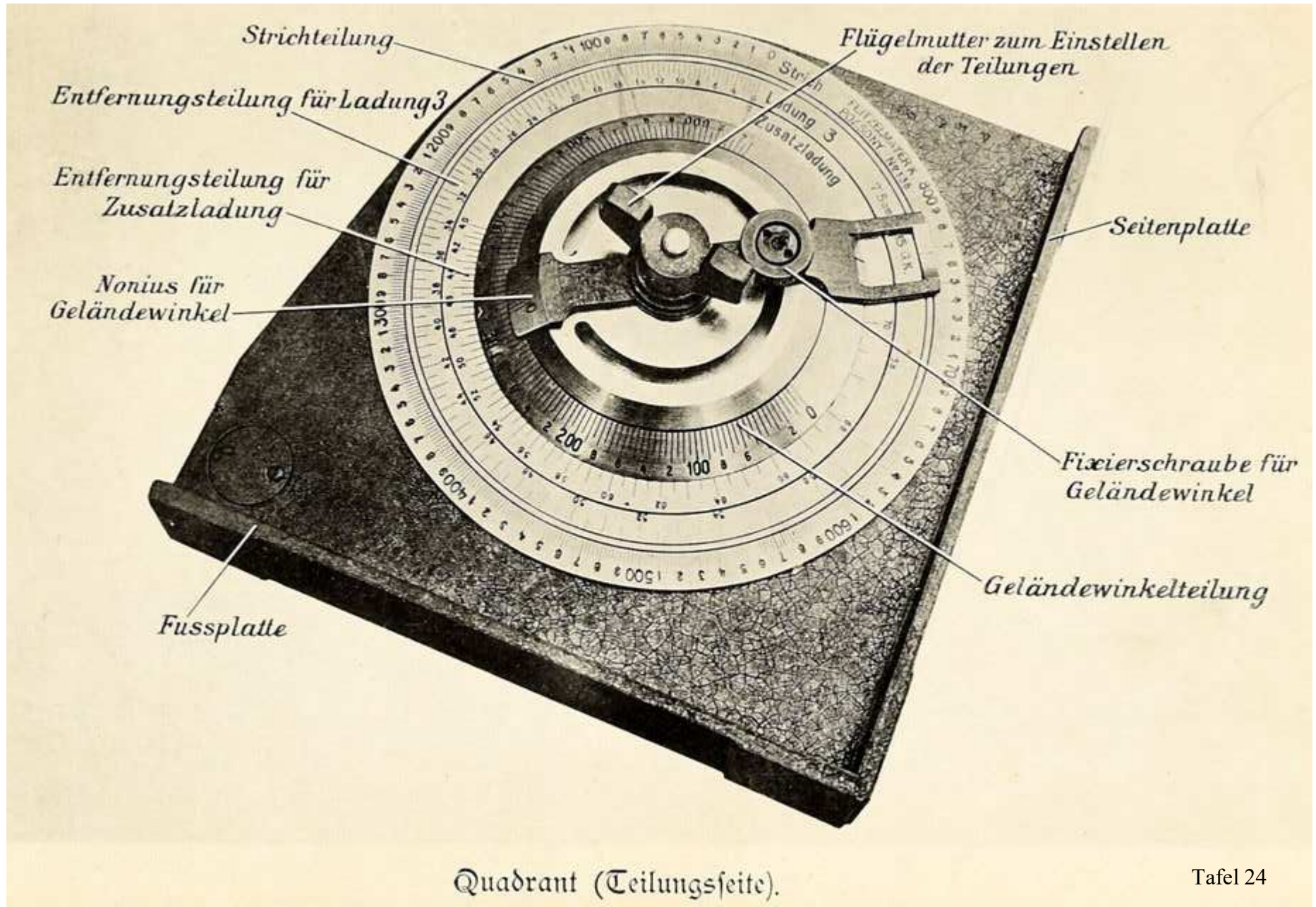

Quadrant (Teilungsseite).

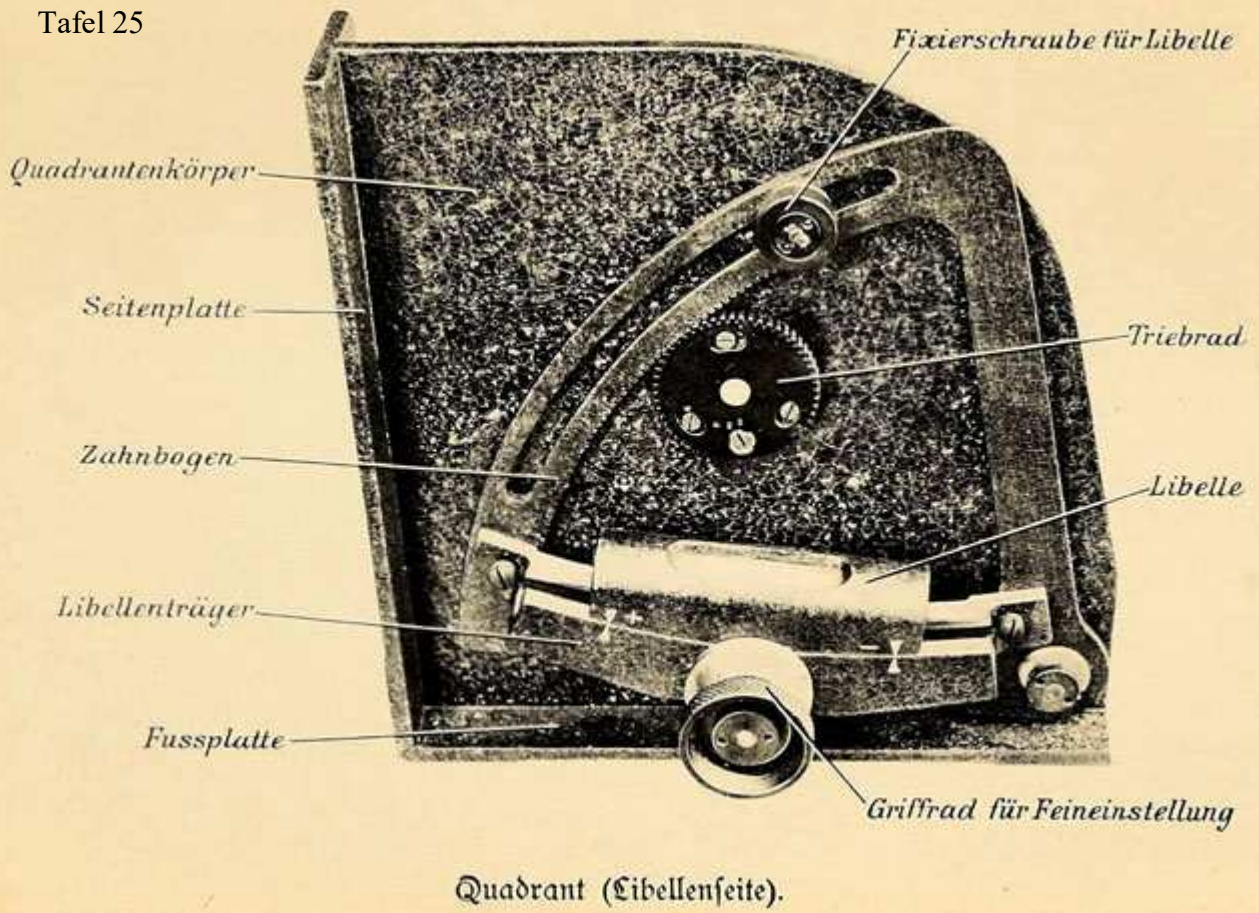

G-Schrapnell

Schrapnell

Granate

Tafel 26



Tafel 27

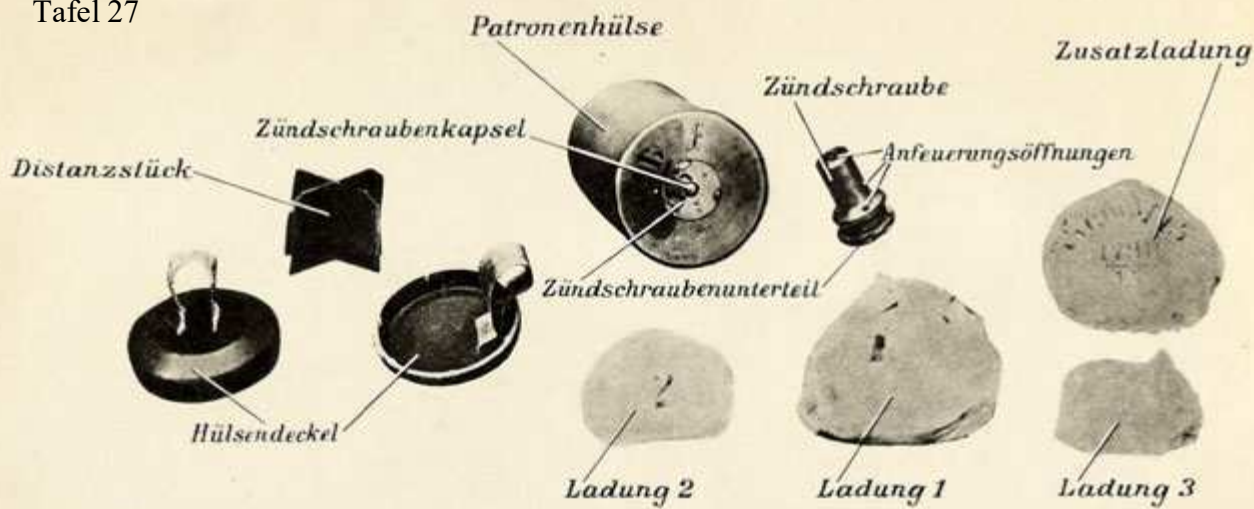

Patronenhülse und Pulverladungen.

Tafel 28

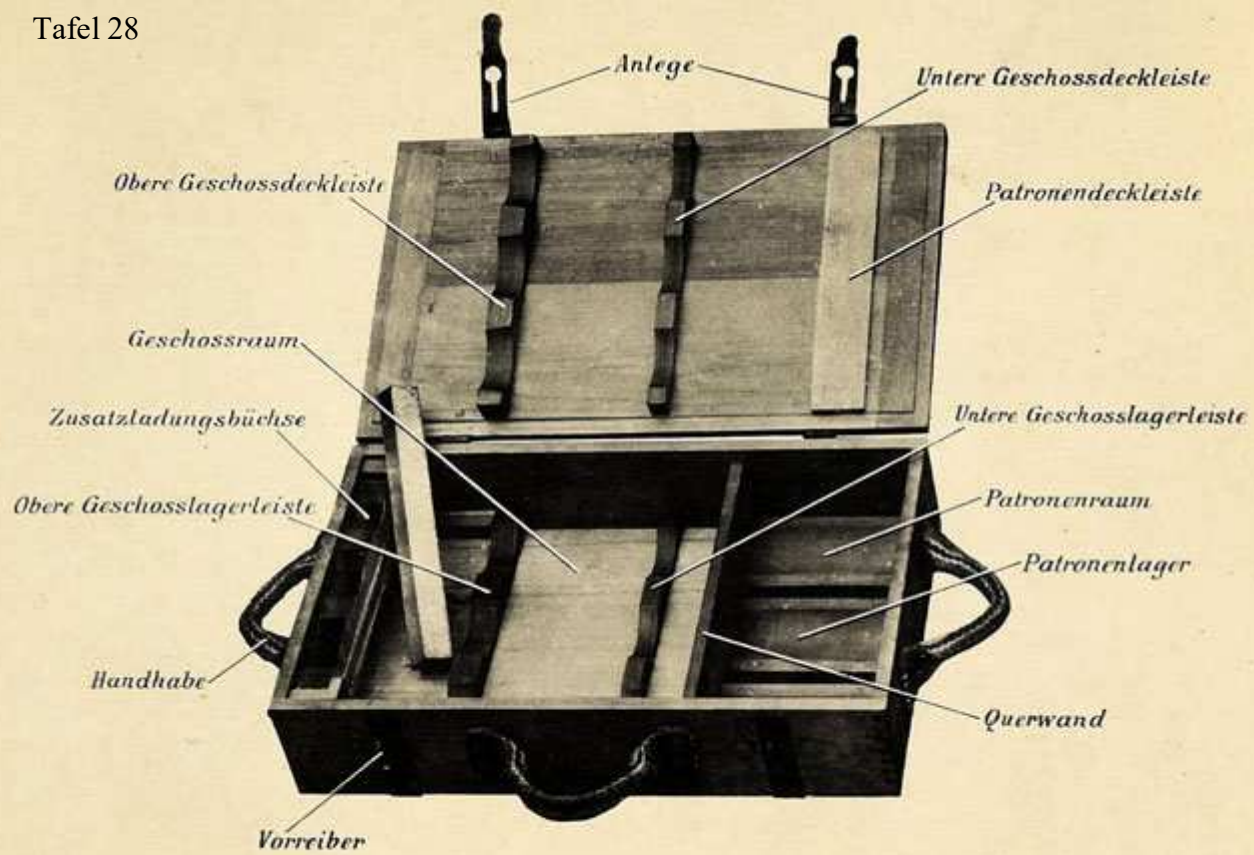

Munitionsverschlag.



Tafel 29

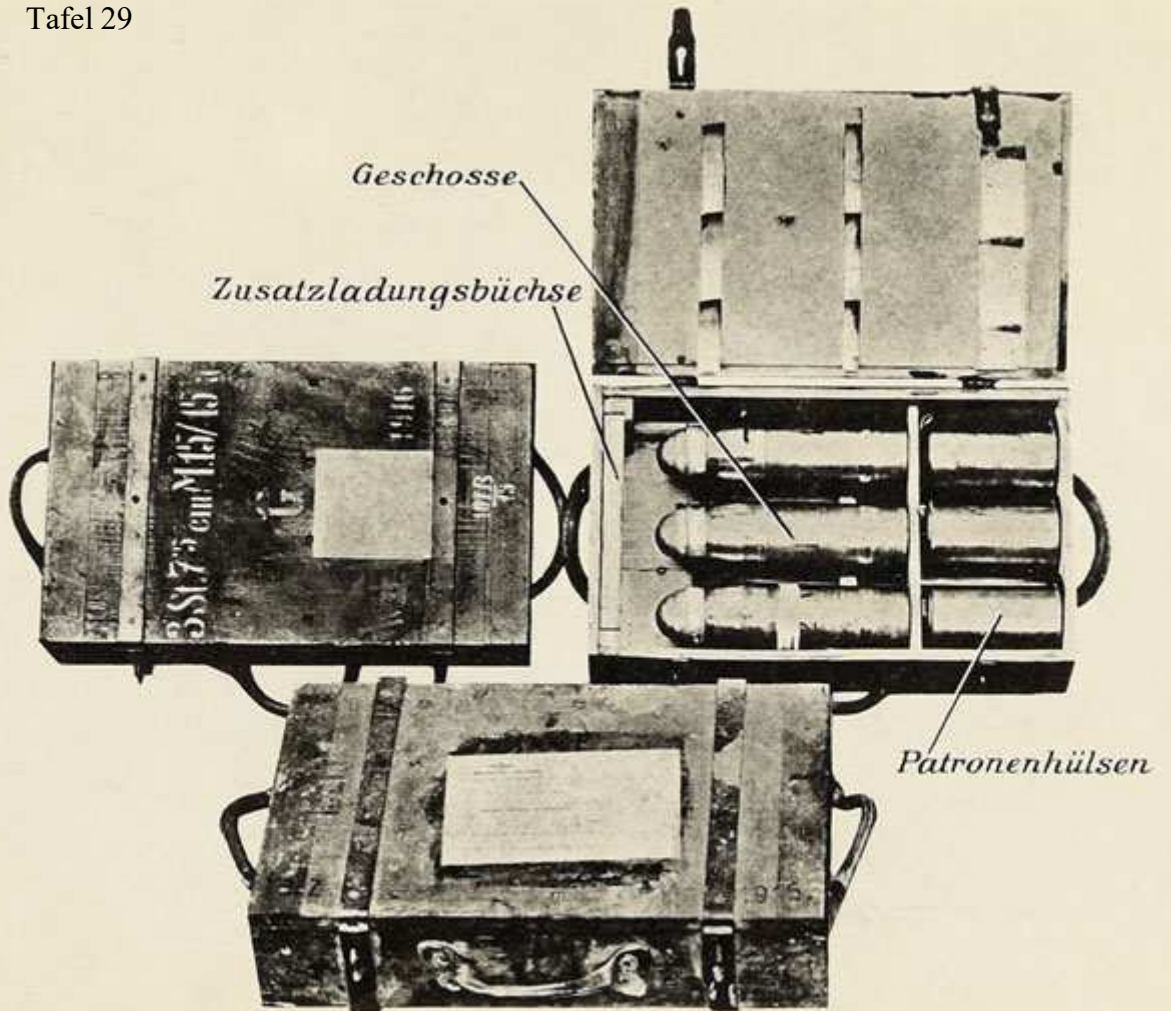

Munitionsverschlage mit Munition.

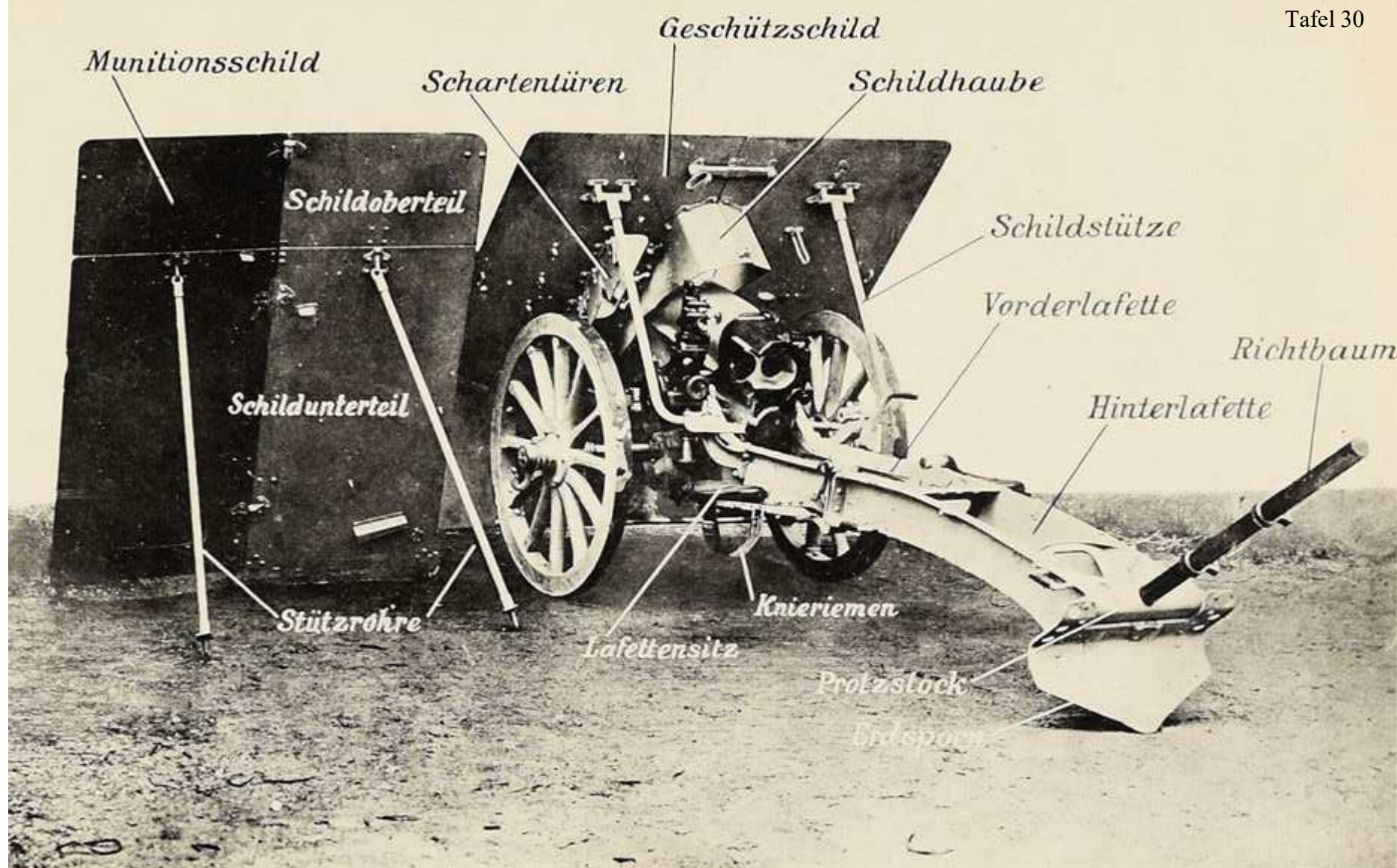

Geschütz samt Munitionsschild in Feuerstellung.

Tafel 31

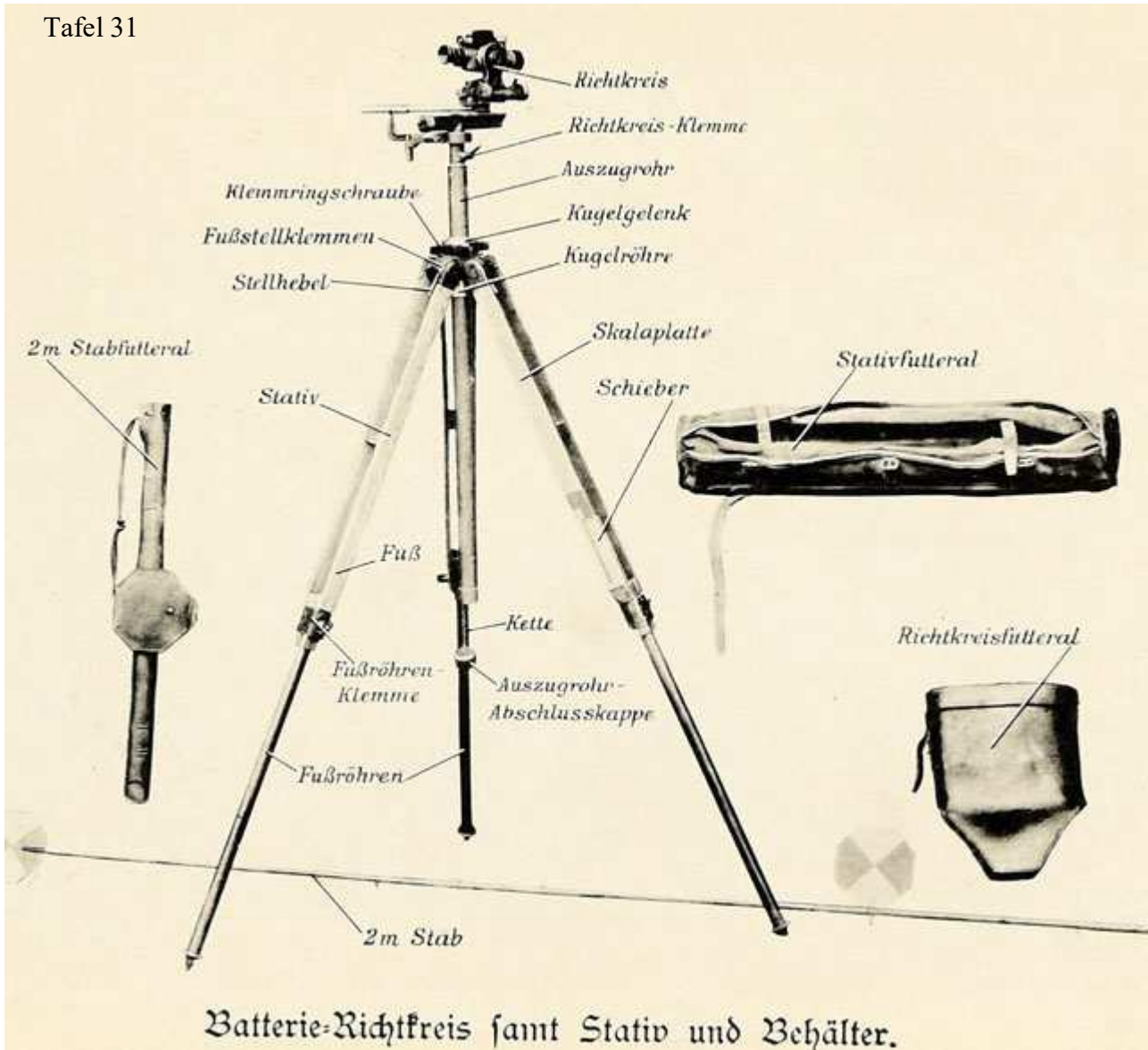

Batterie-Richtkreis samt Stativ und Behälter.

Tafel 32

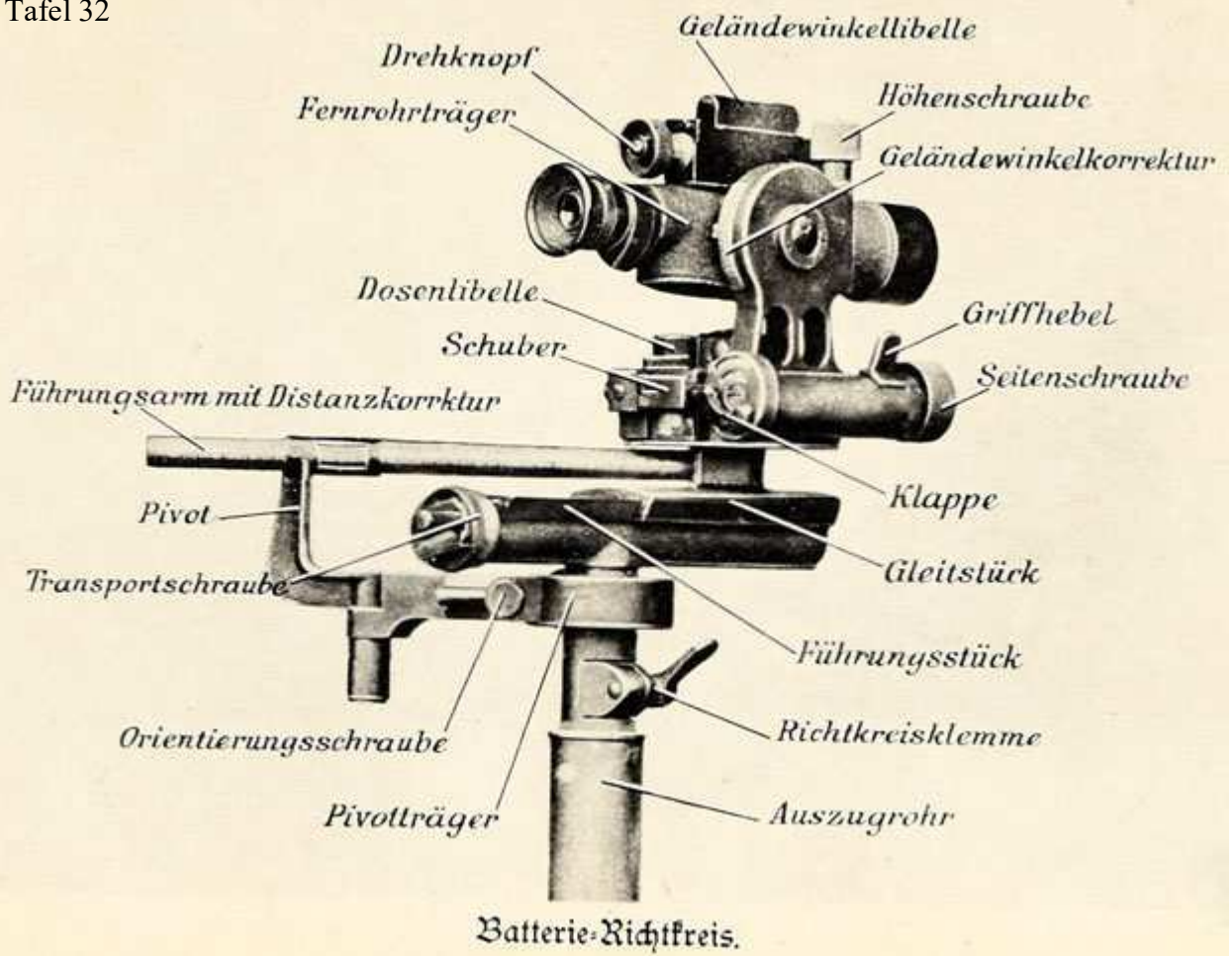



15-faches Doppel-fernrohr samt Winkelspiegelrohr, Stativ und Behälter, mit Beobachterschild.

Tafel 34

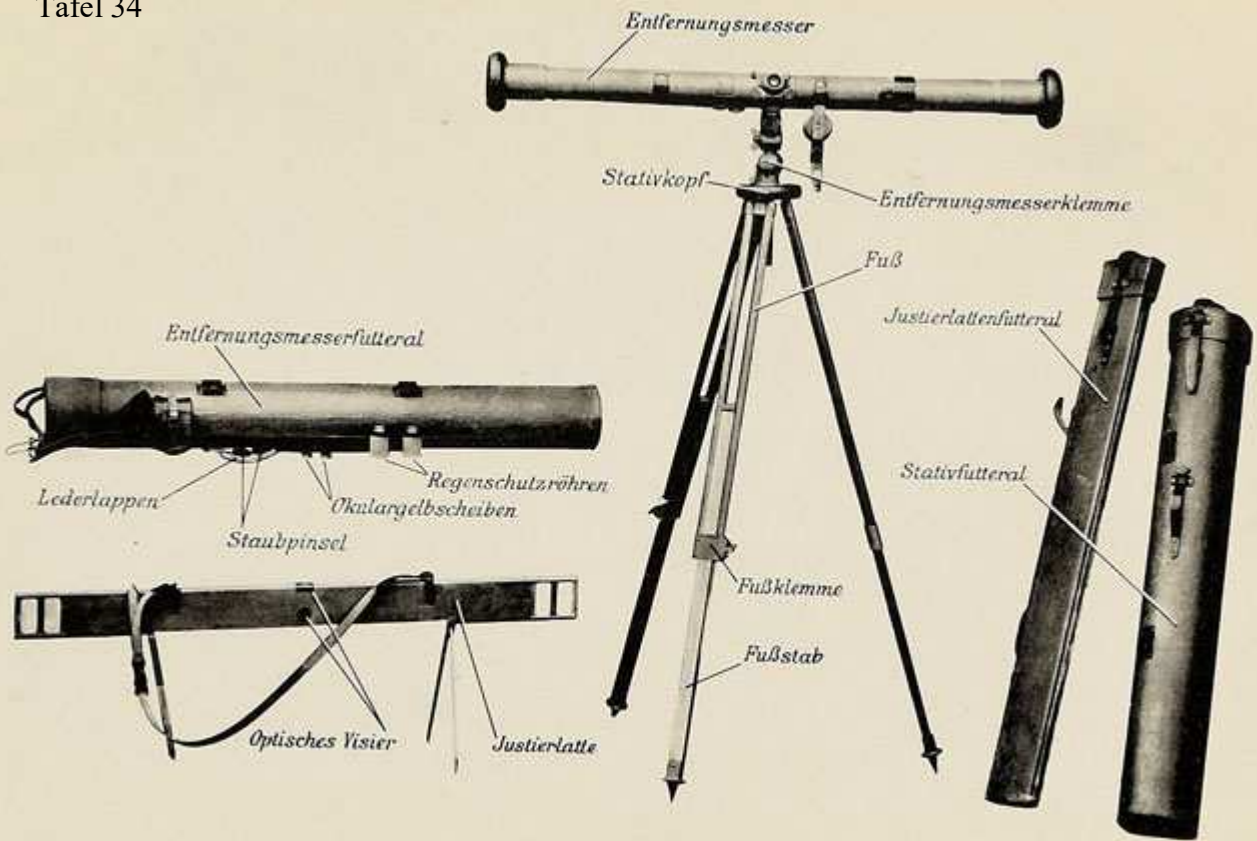

Entfernungsmesser samt Stativ und Behälter.

Tafel 35

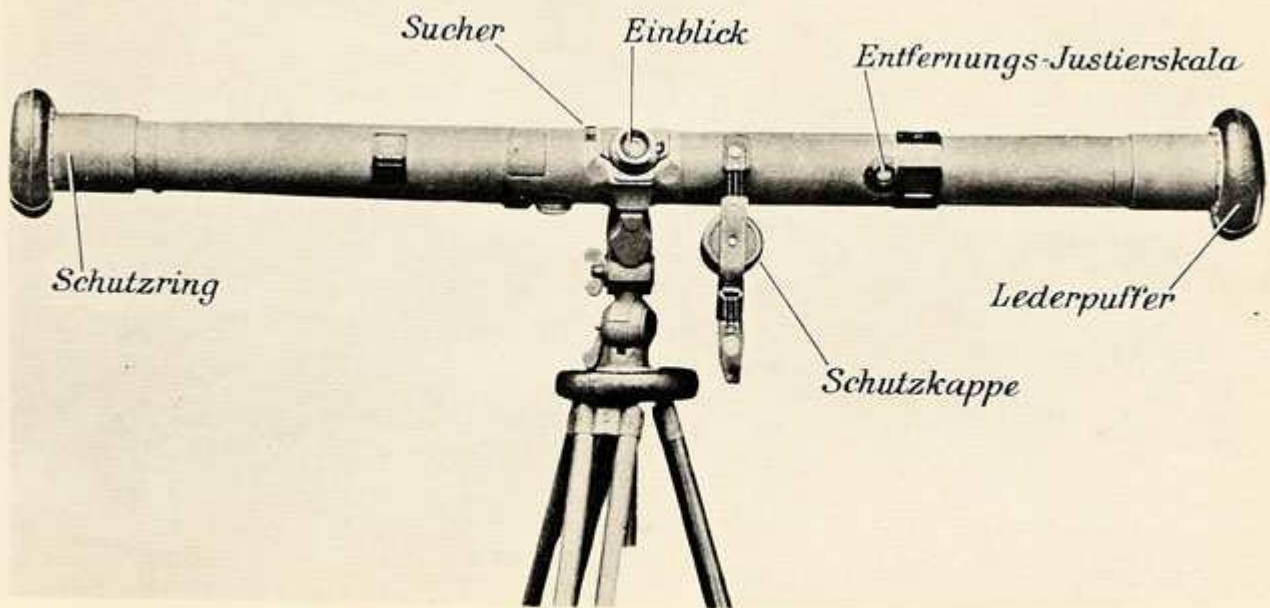

Entfernungsmesser.

Tafel 36

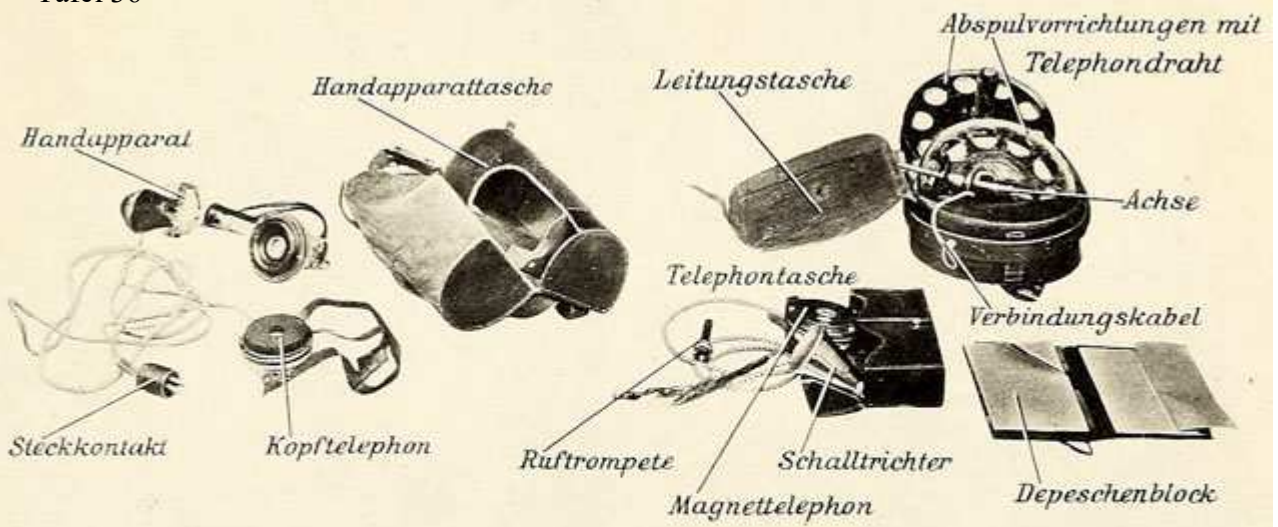

Telefon-Handapparat und Leitungstasche.

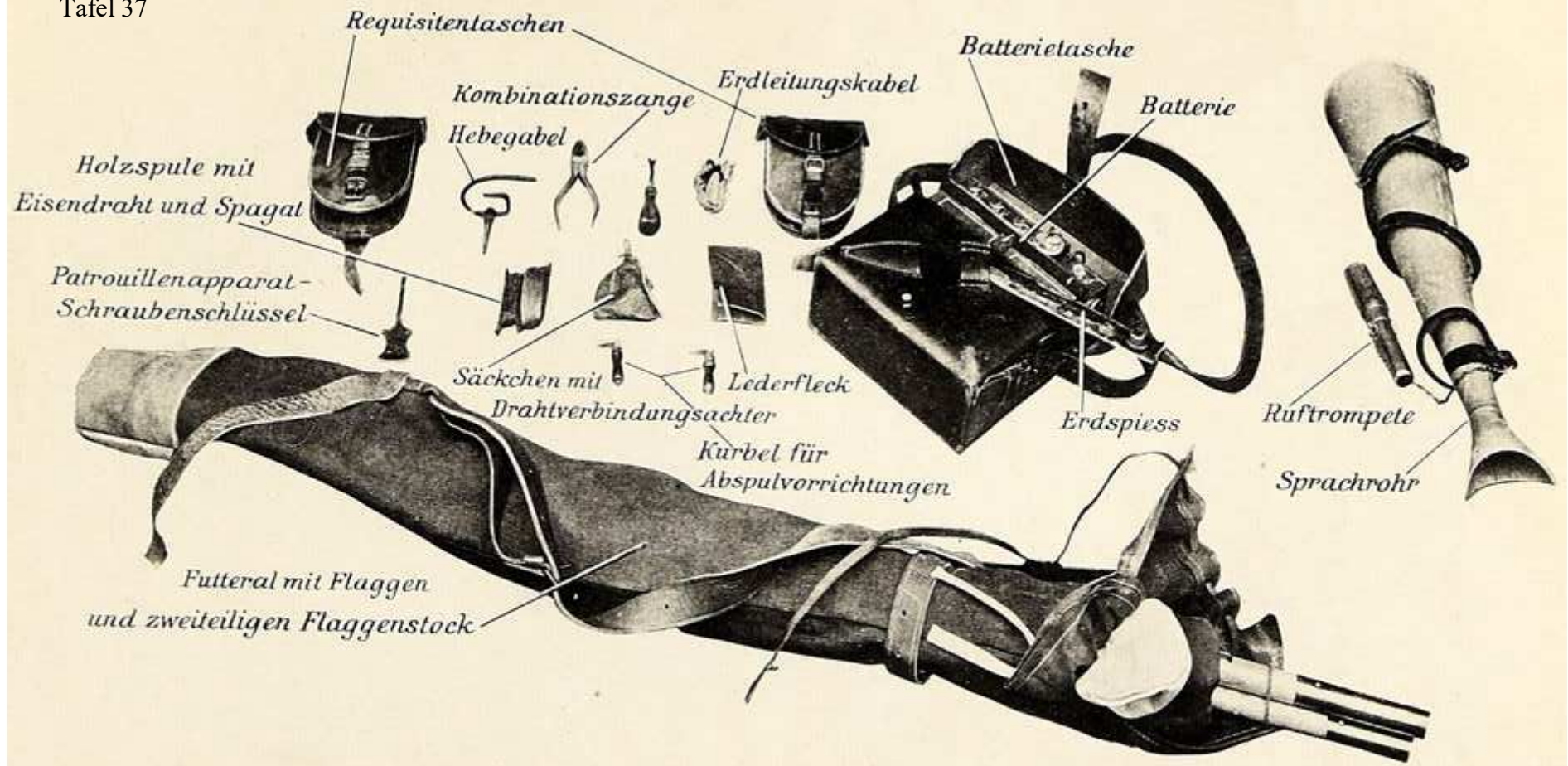

Telefon-Batterietasche und Signalgarnitur samt Behälter.



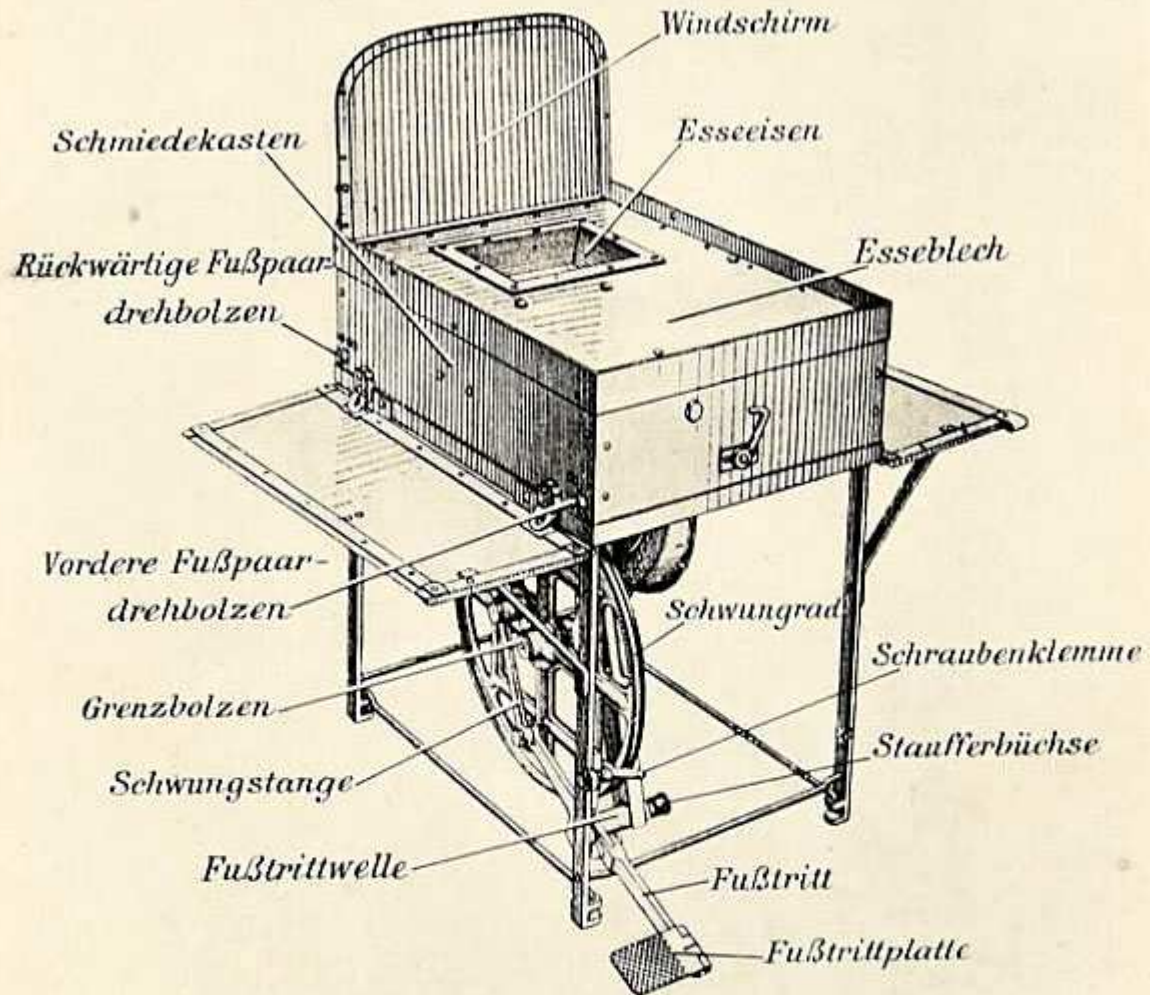

feldschmiede (gebrauchsfertig).

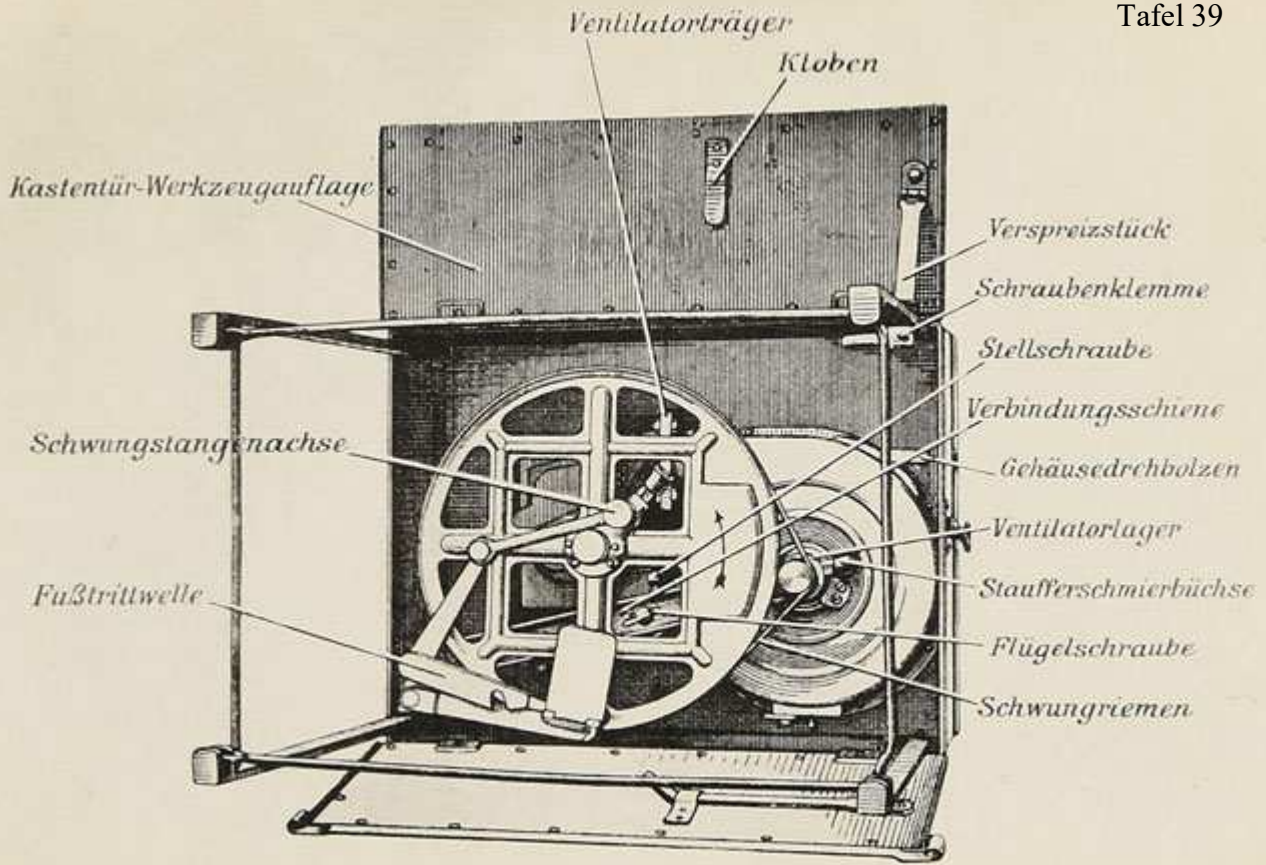

feldschmiede (halb zusammengelegt, Ansicht von unten).

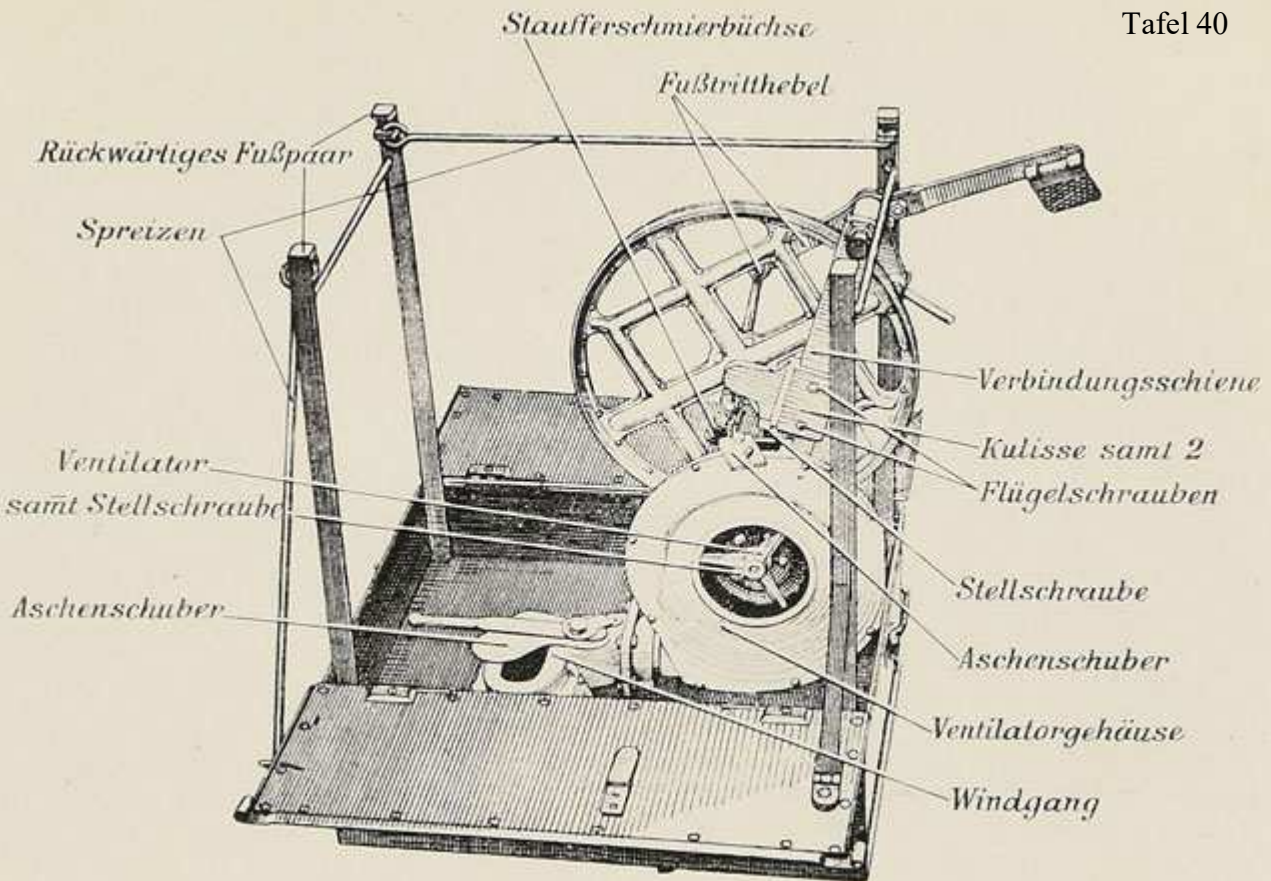

feldschmiede (Ansicht von unten).

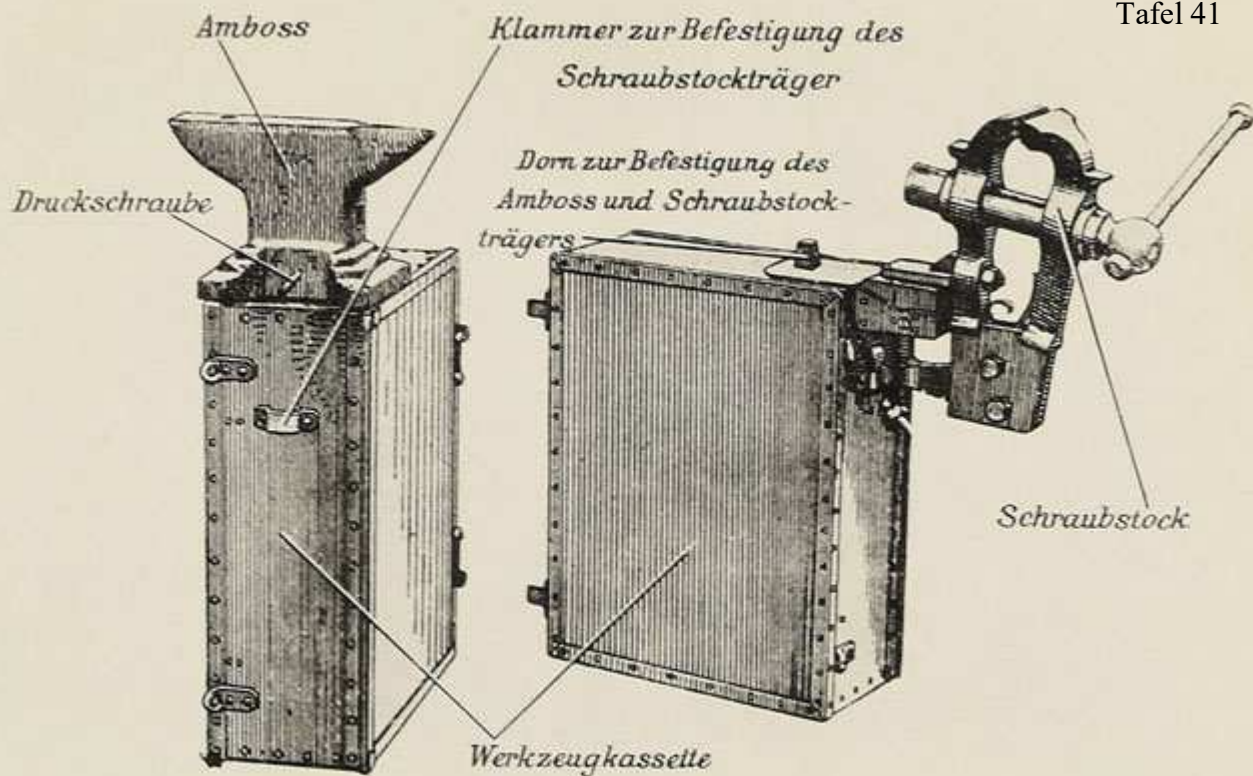

Werkzeugkassette mit Amboss, bezw. mit Schraubstock.

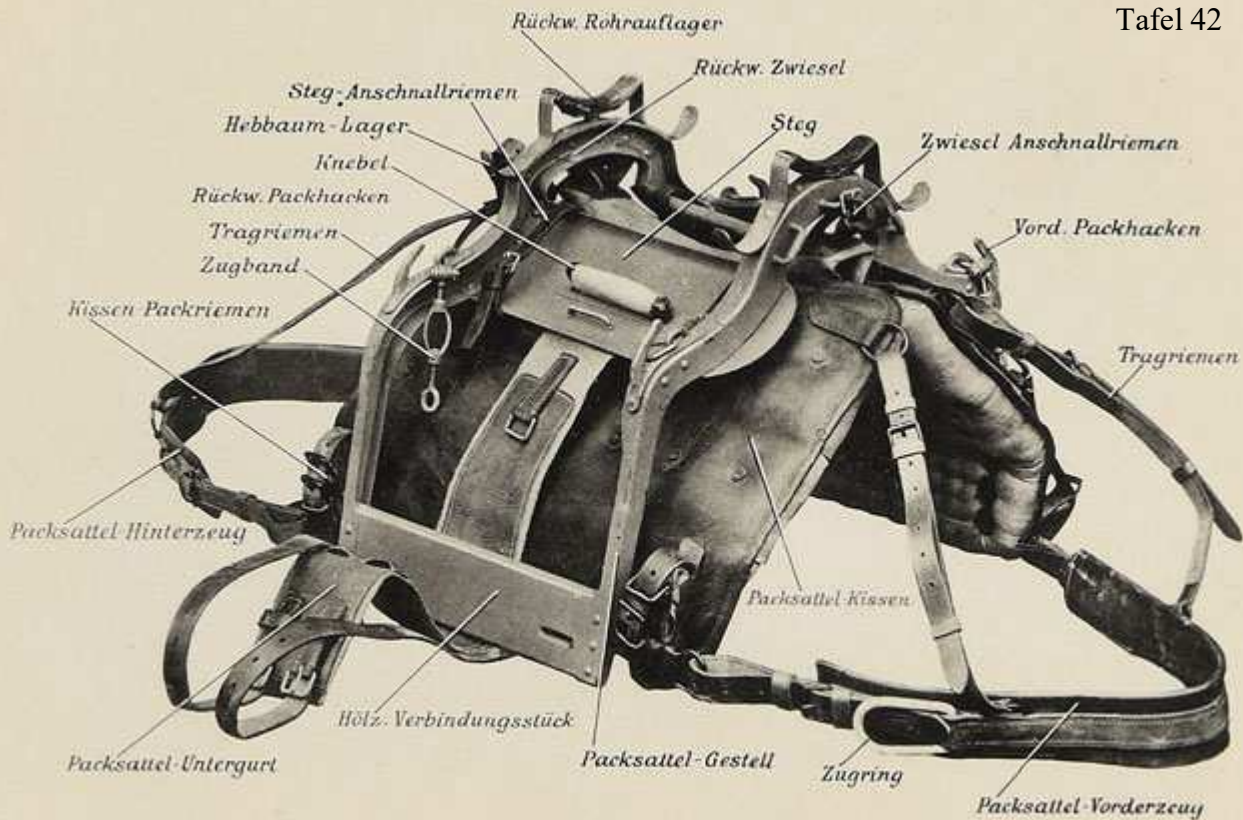

Geschütz-Packsattel (Rohr-Packsattel).

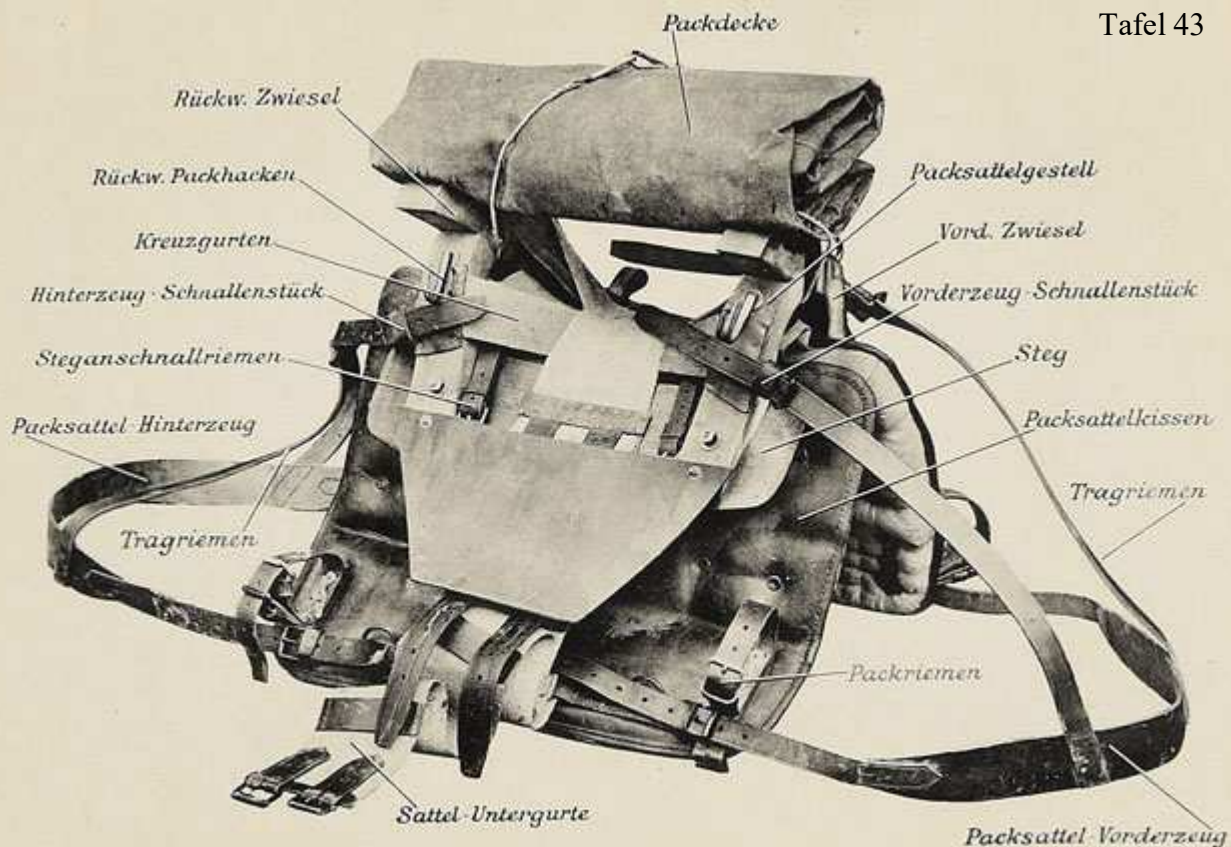

Munitions- und Bagage-Packsattel.

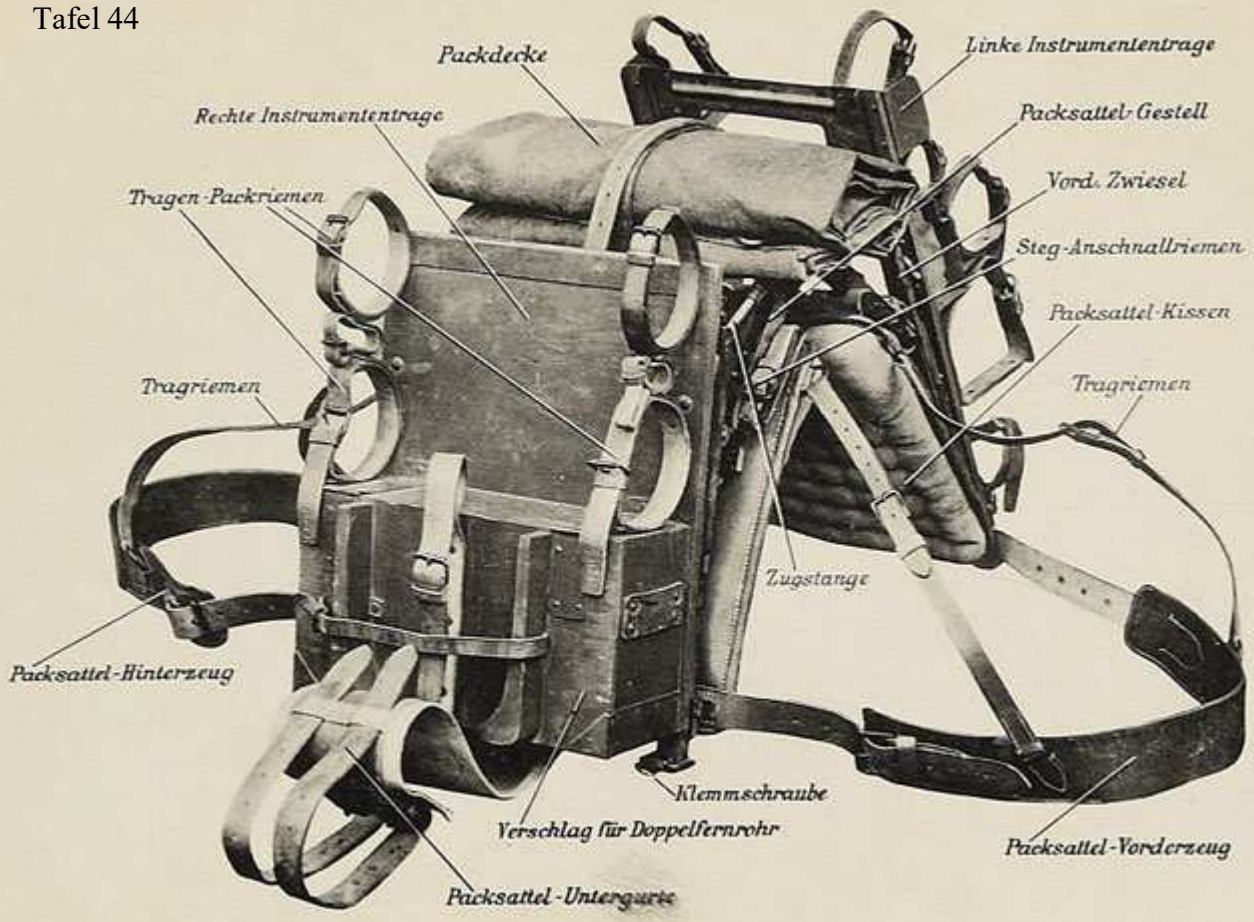

Instrumenten-Packsattel.

Tafel 45

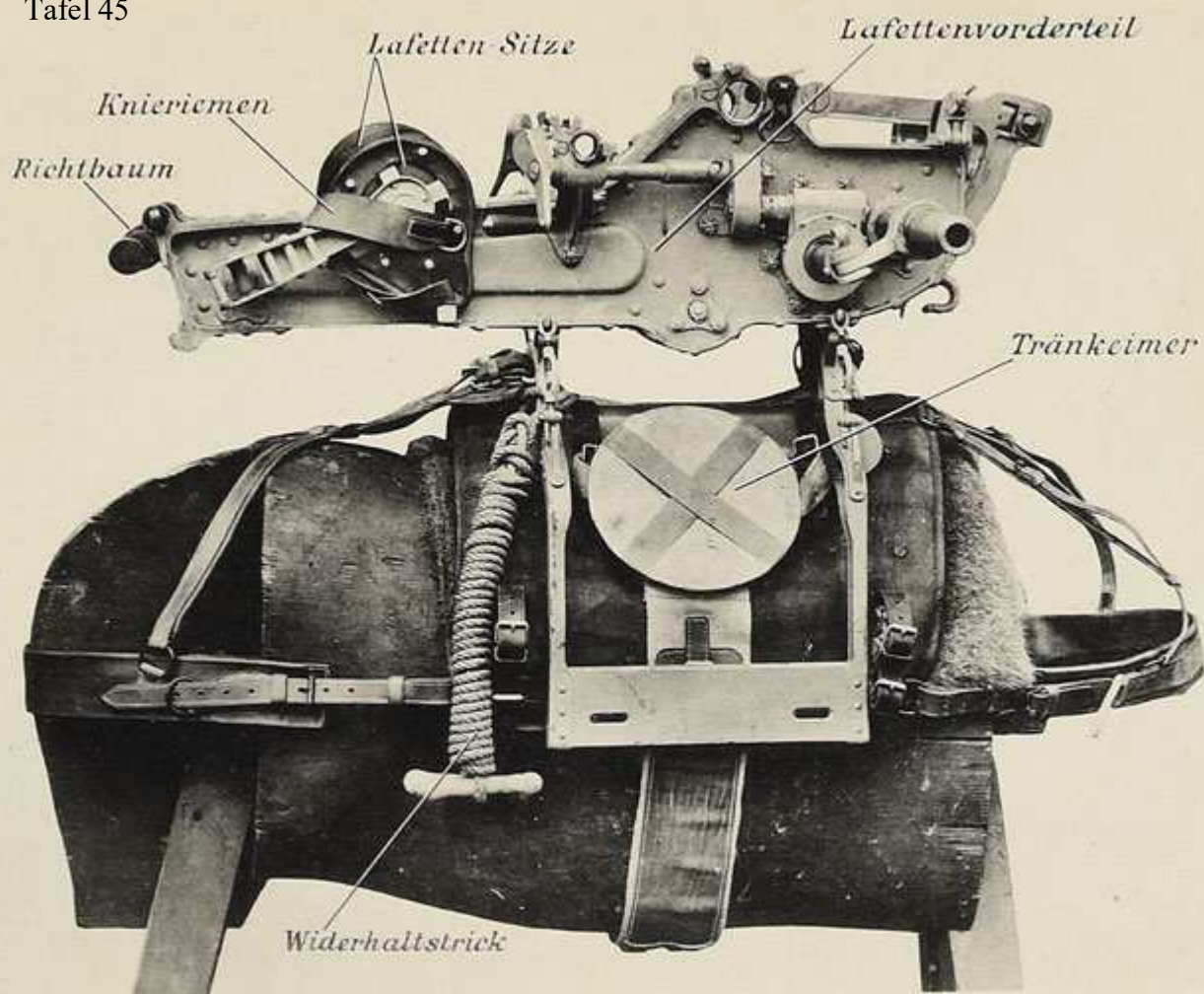

Vorderlafetten-Tragtier.

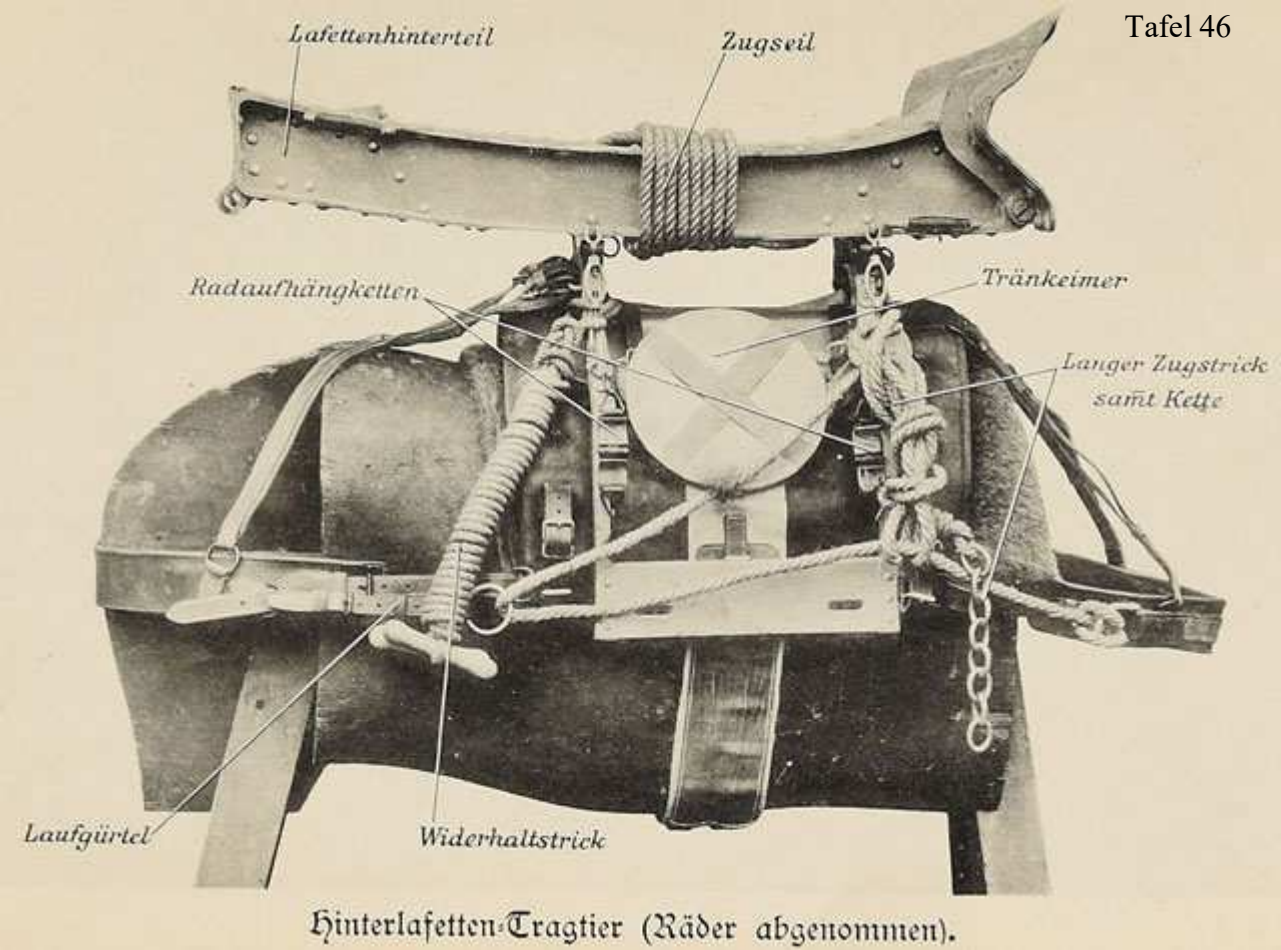

Hinterlafetten-Tragtier (Räder abgenommen).

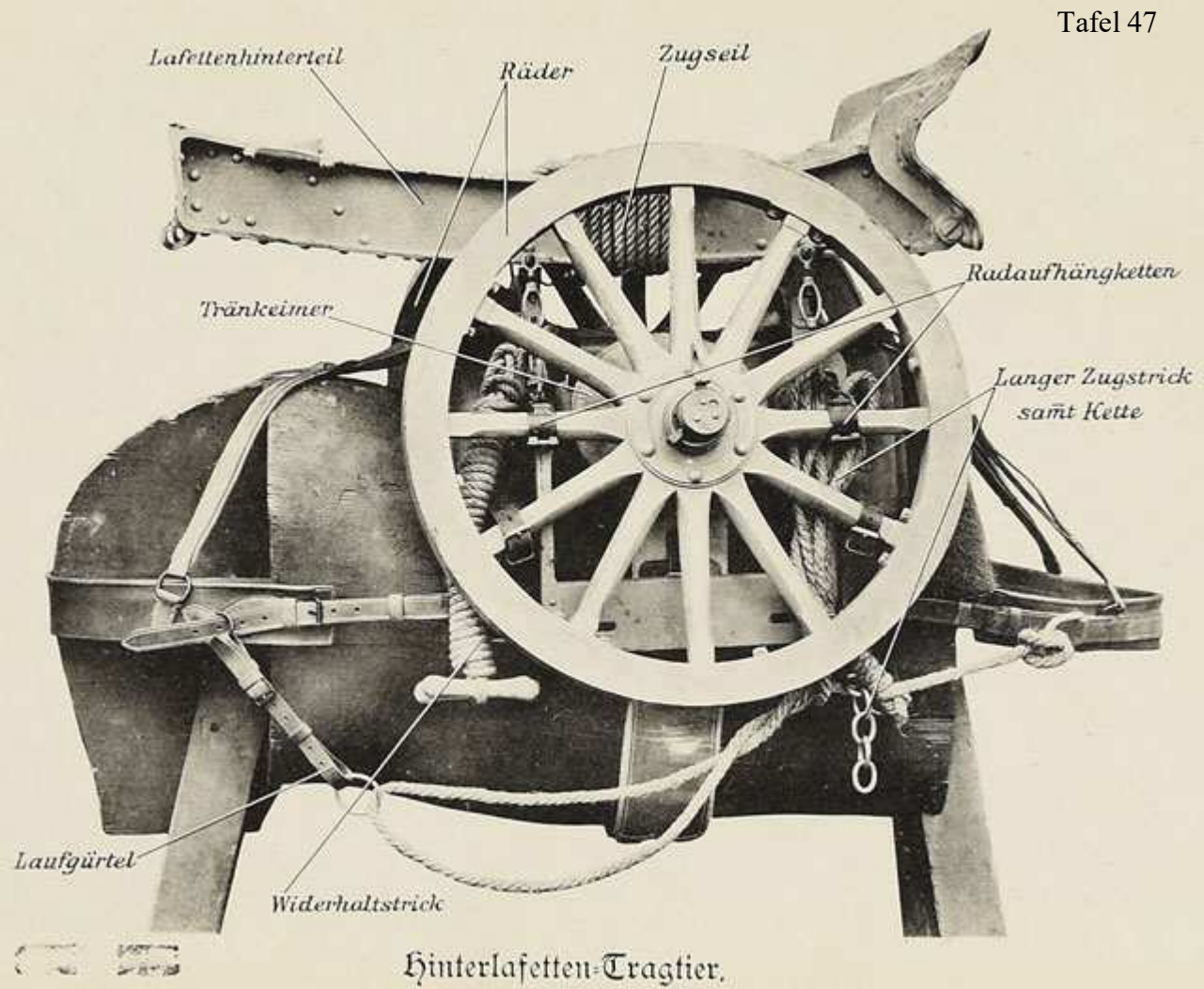

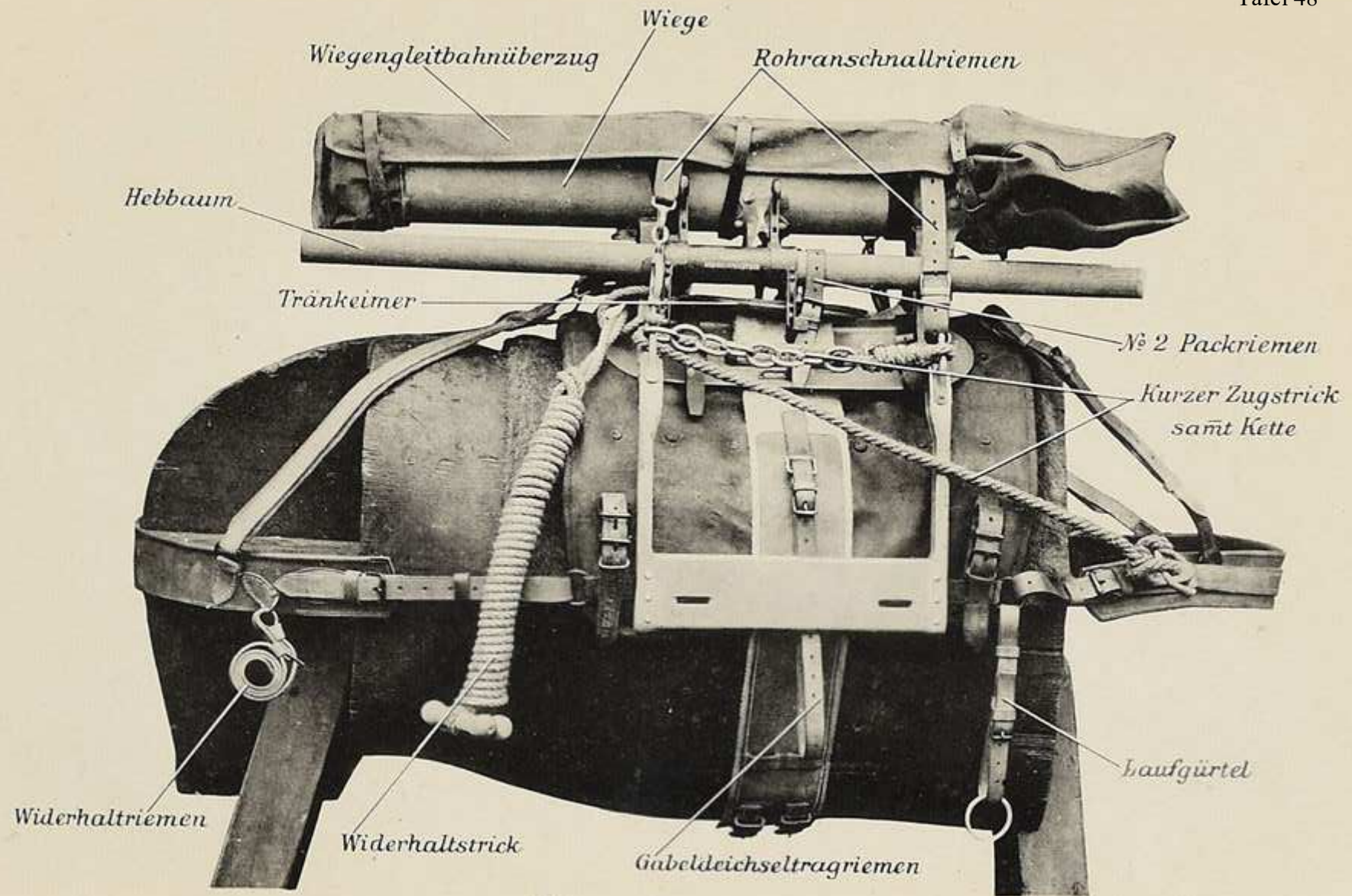

Wiegen-Tragtier.



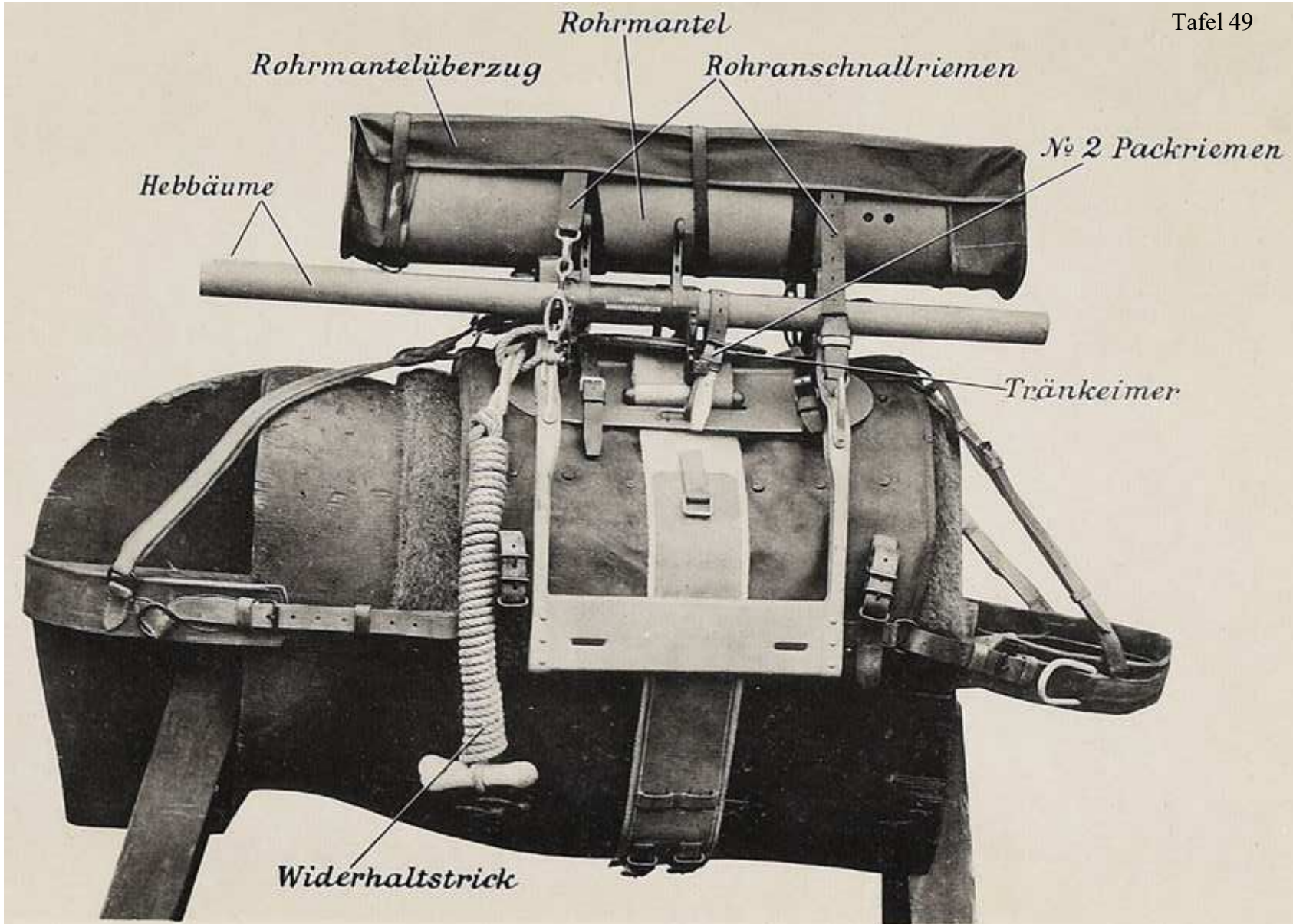

Rohrmantelüberzug

Rohrmantel

Rohranschnallriemen

No 2 Packriemen

Hebbäume

Tränkeimer

Widerhaltstrick

Rohrmantel-Tragtier.

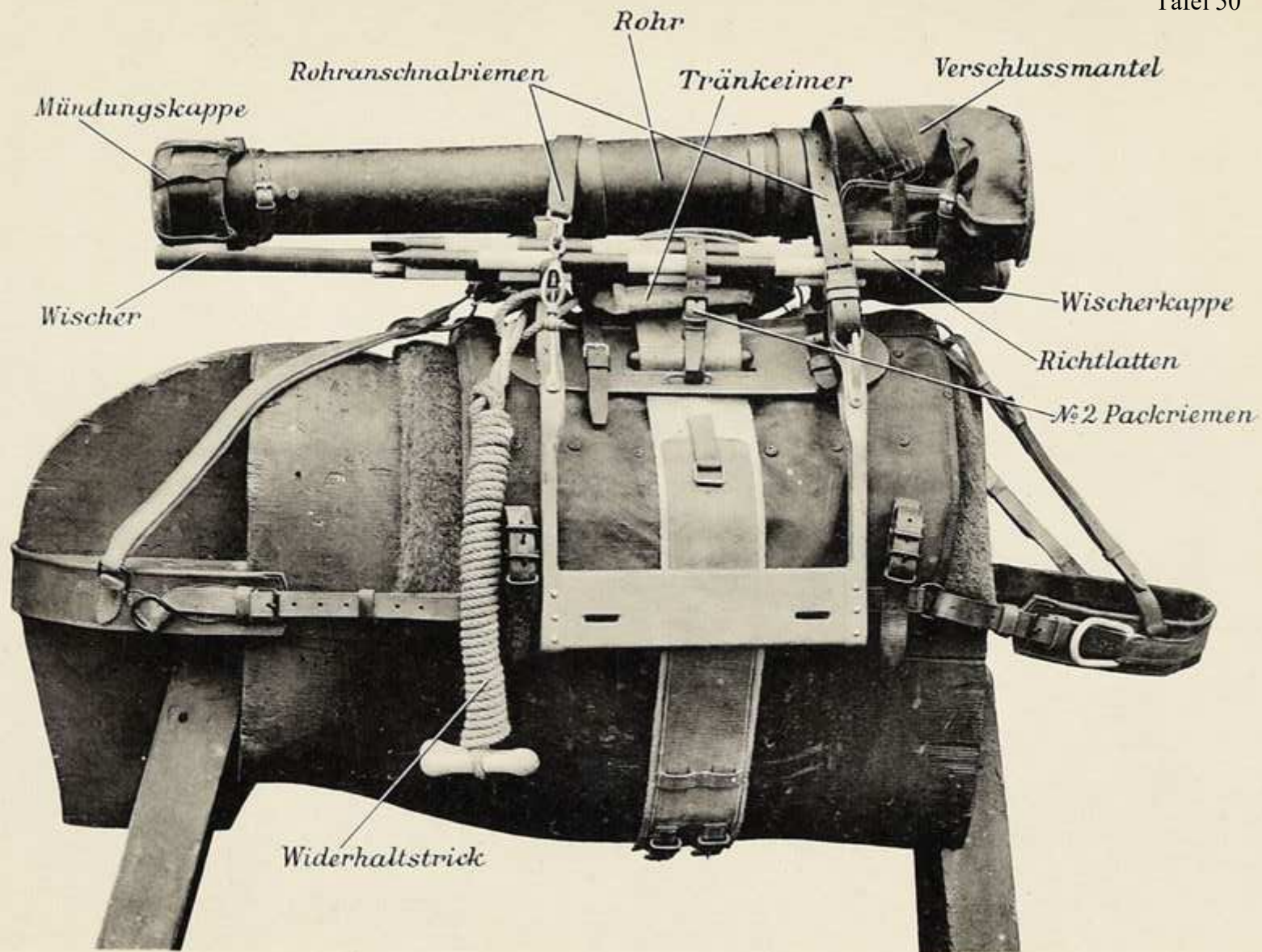

Rohr-Tragtier.

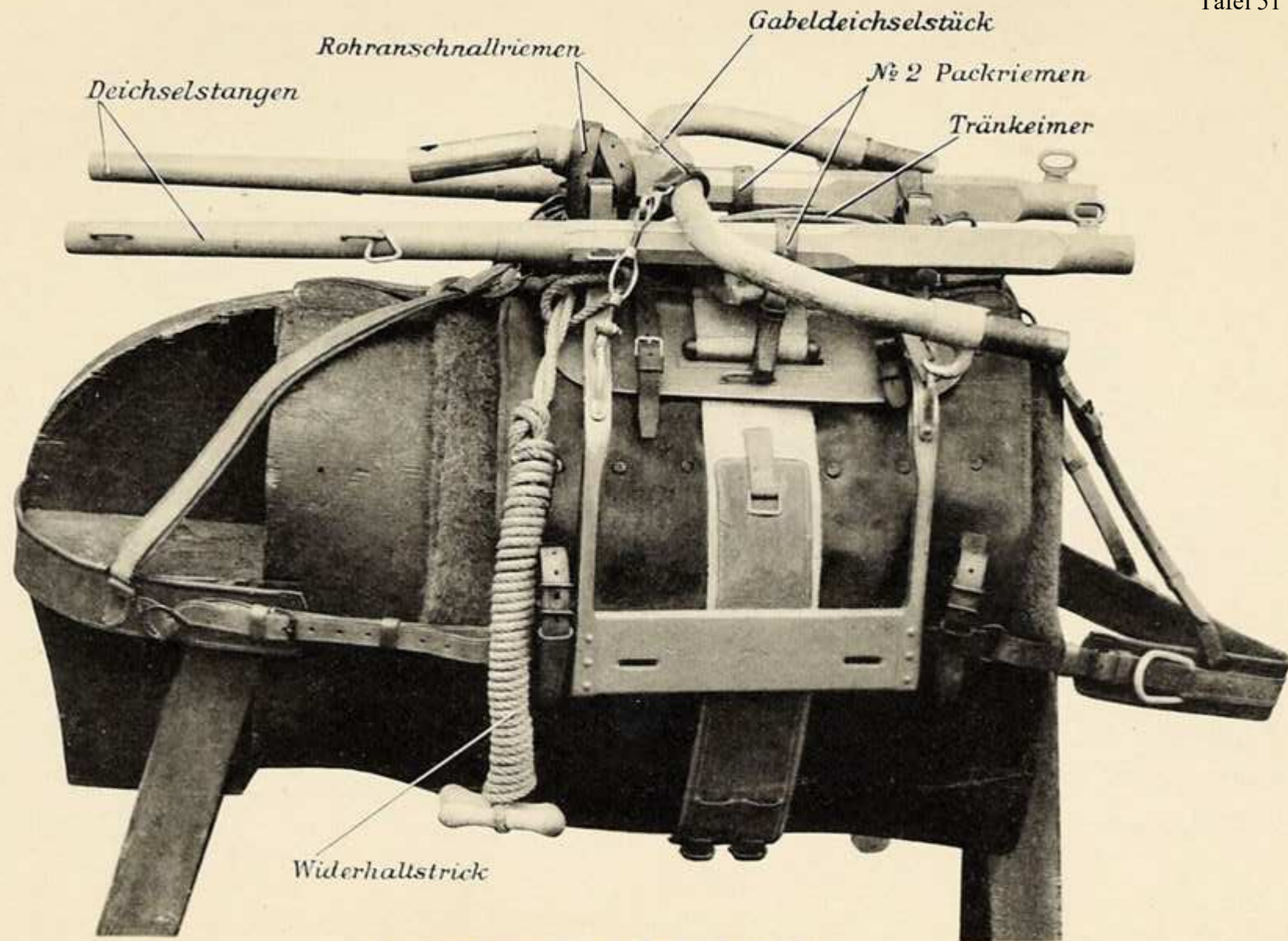

Widerhaltstrick

Auspackung der Gabeldeichsel.

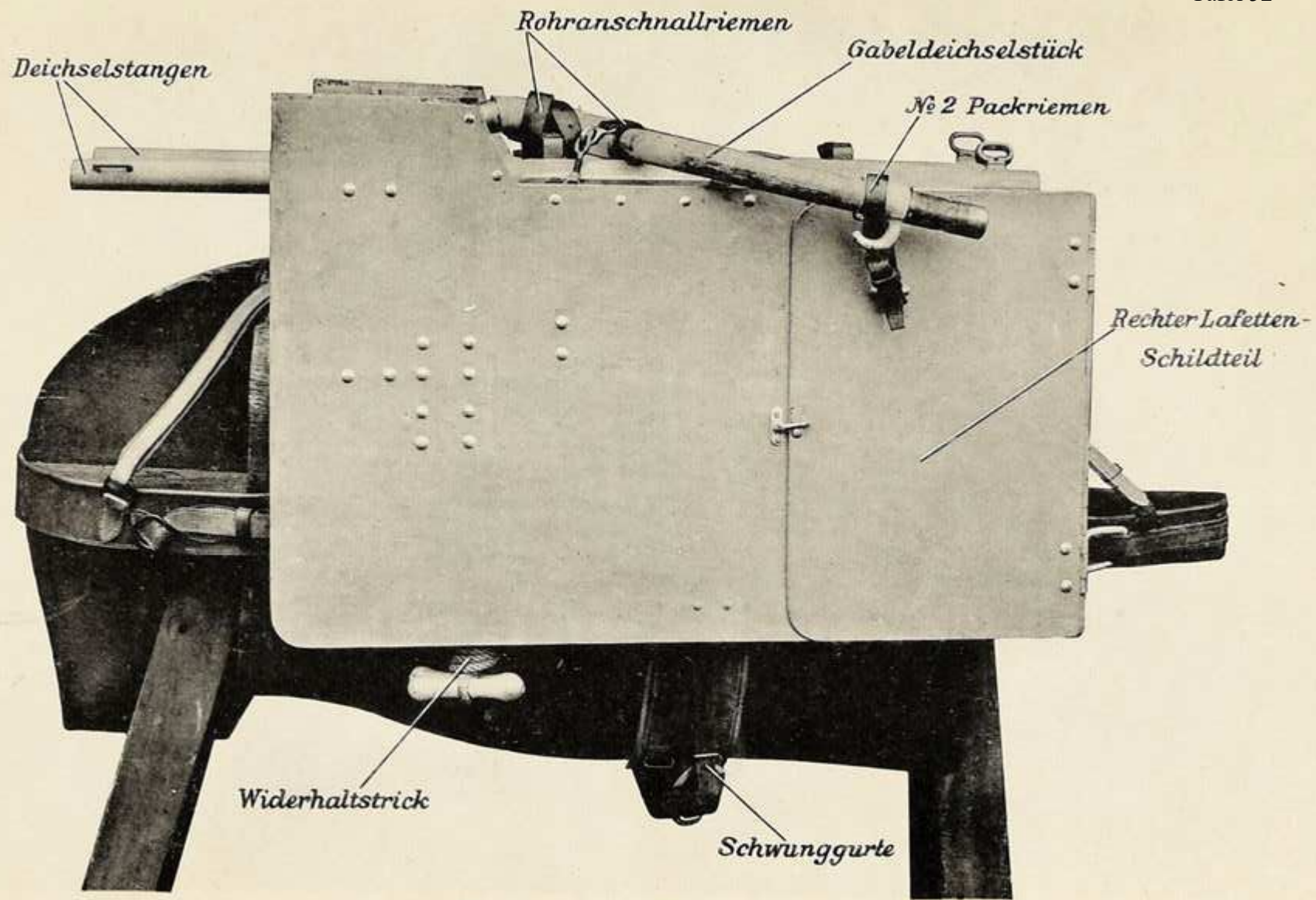

Lafettenschild-Tragtier.

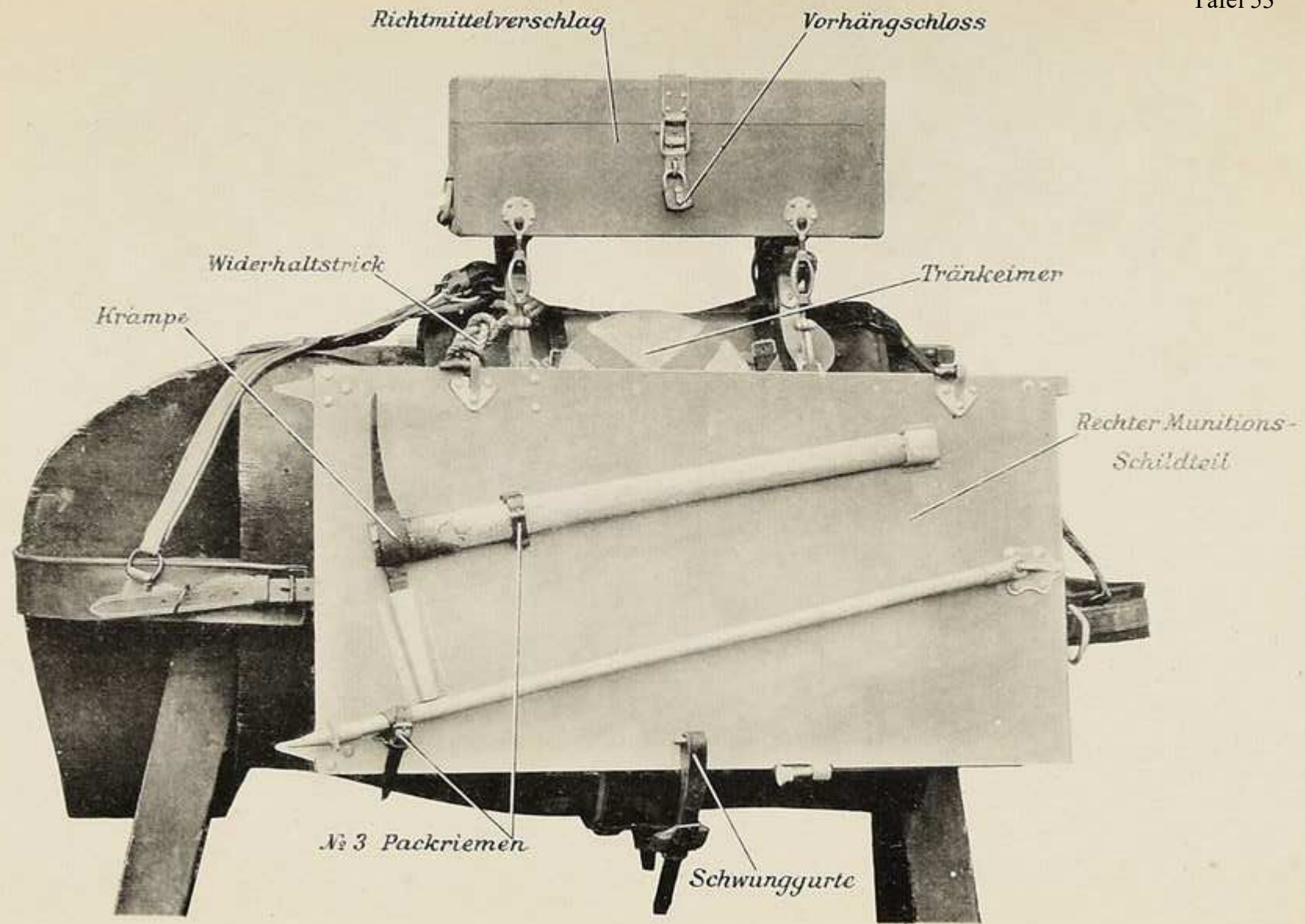

Munitionsschild-Tragtier.

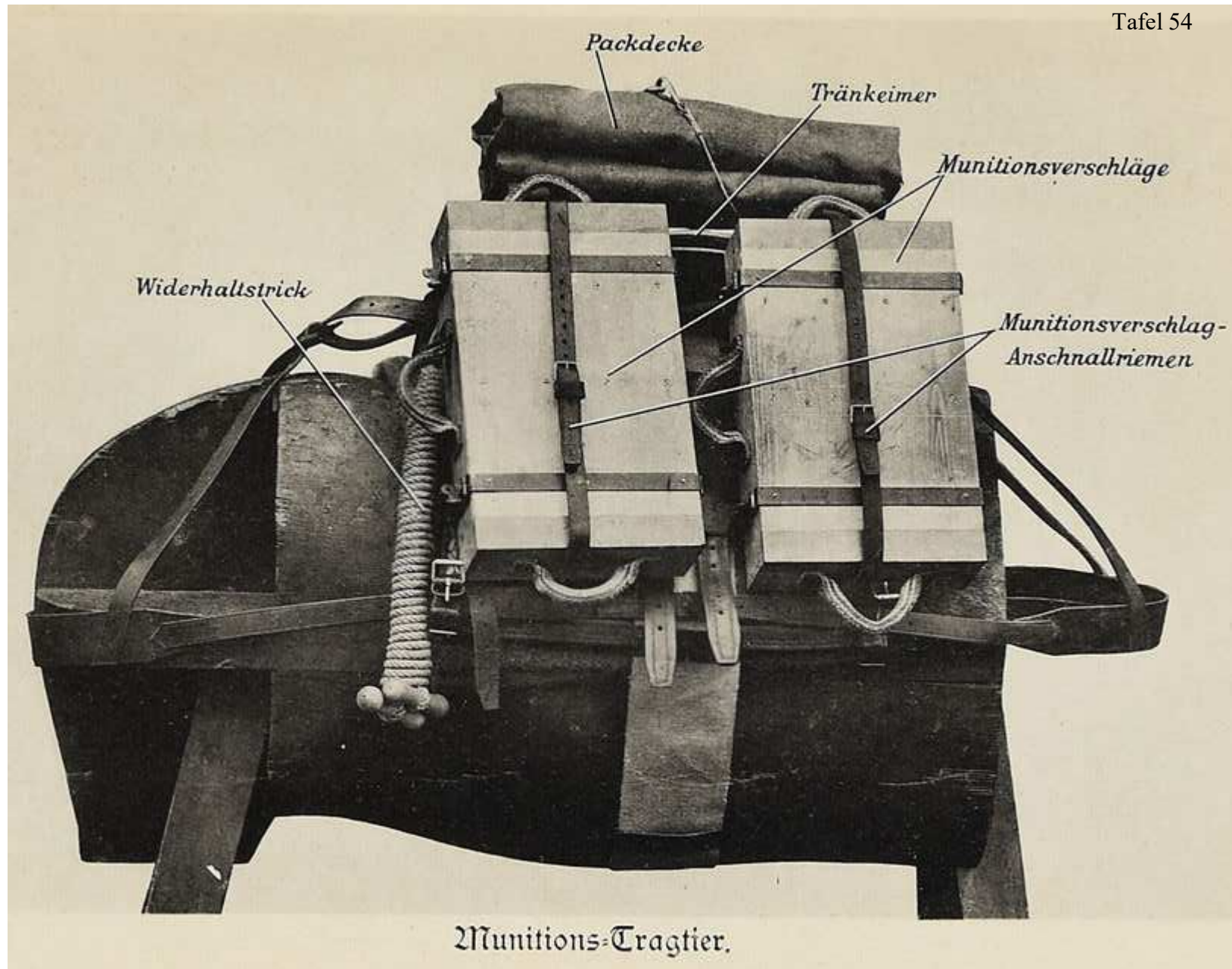

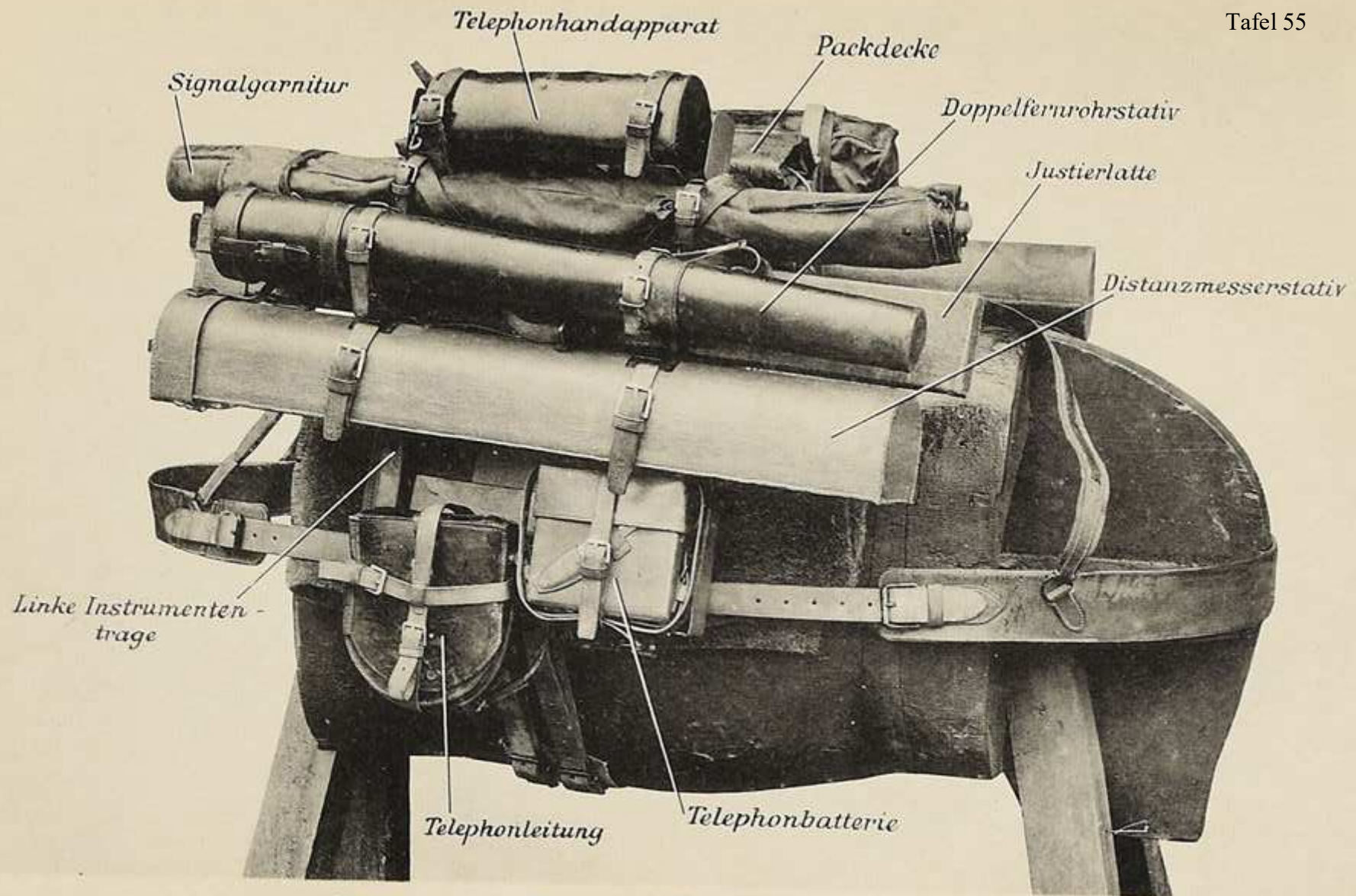

Instrumenten-Tragtier (Ansicht von links).

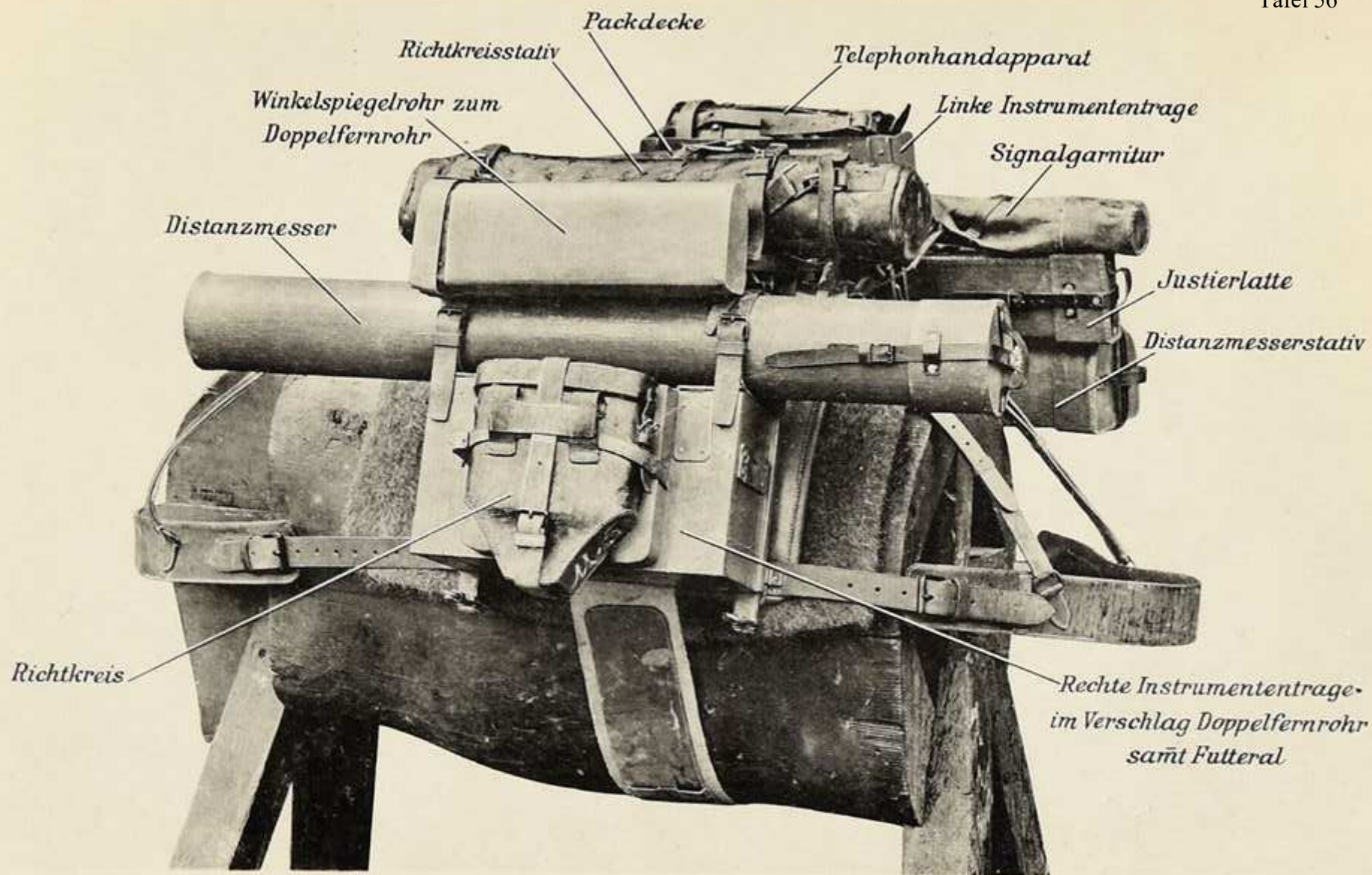

Instrumenten-Tragtier (Ansicht von rechts).



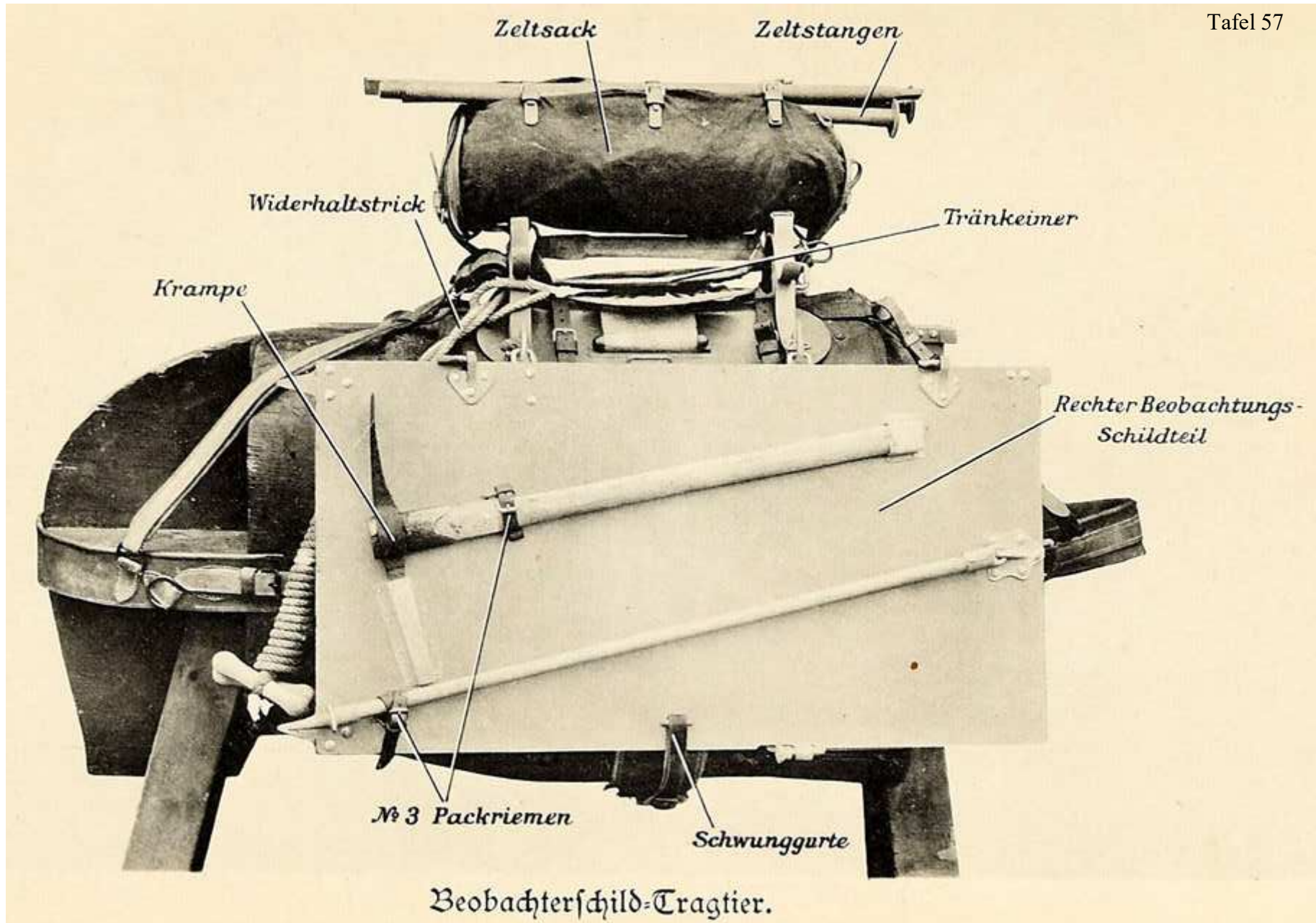

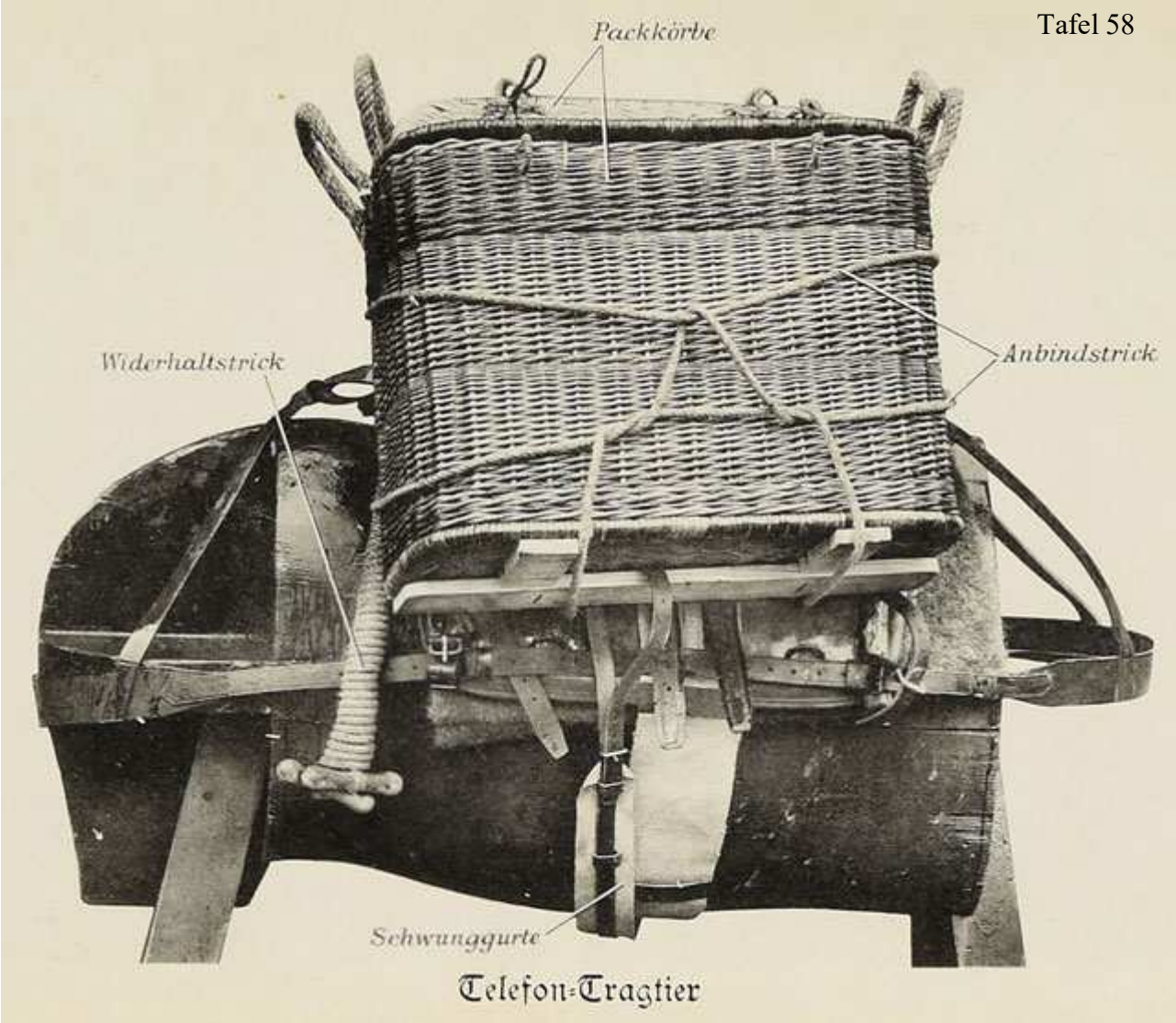

Packkörbe

Widerhaltstrick

Anbindstrick

Schwunggurte

Telefon-Tragtier



Requisitenverschlag-Tragtier (Verschläge Nr 1 und 2).

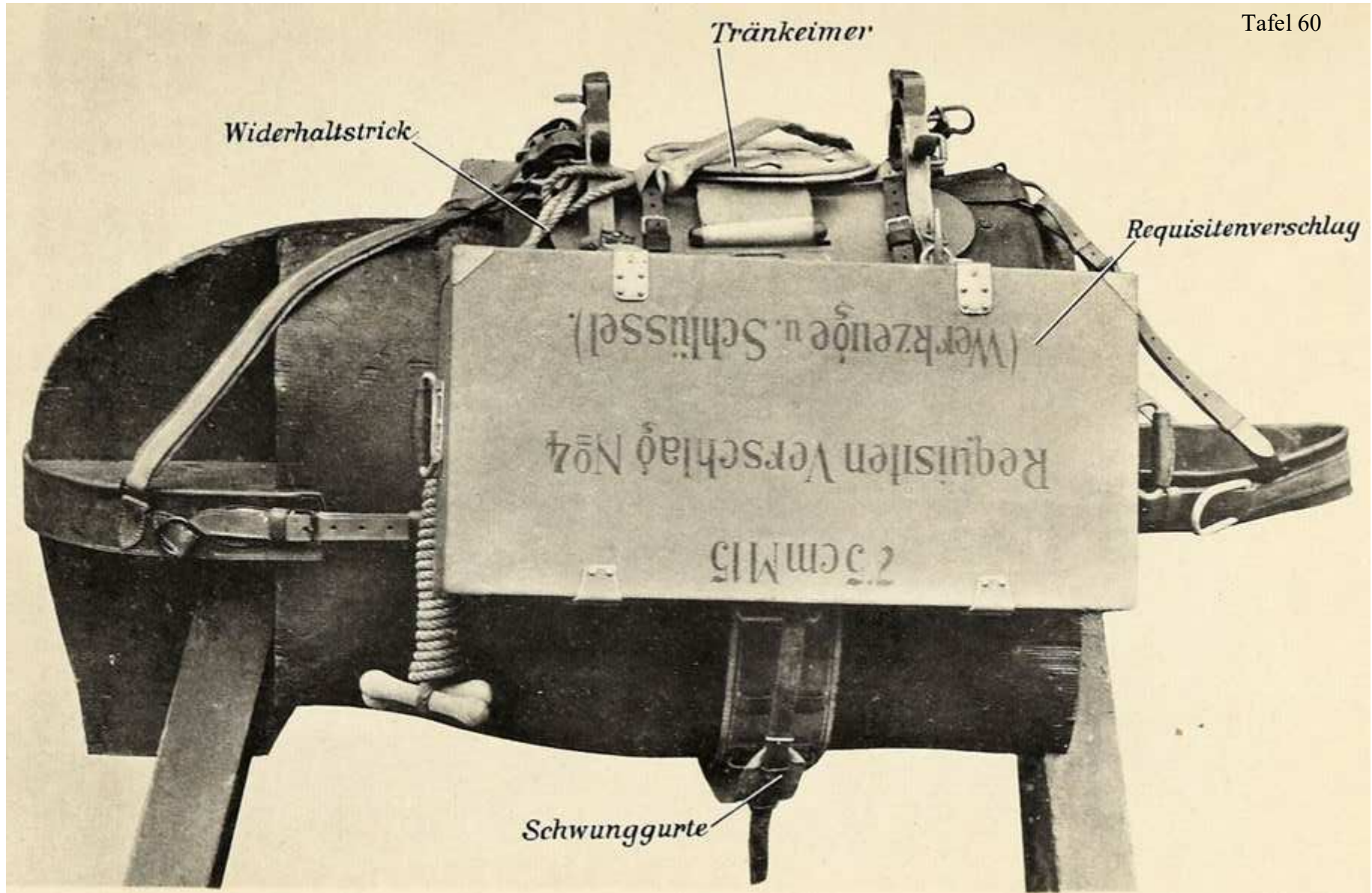

Requisitenverschlag-Tragtier (Verschläge Nr. 3 und 4).

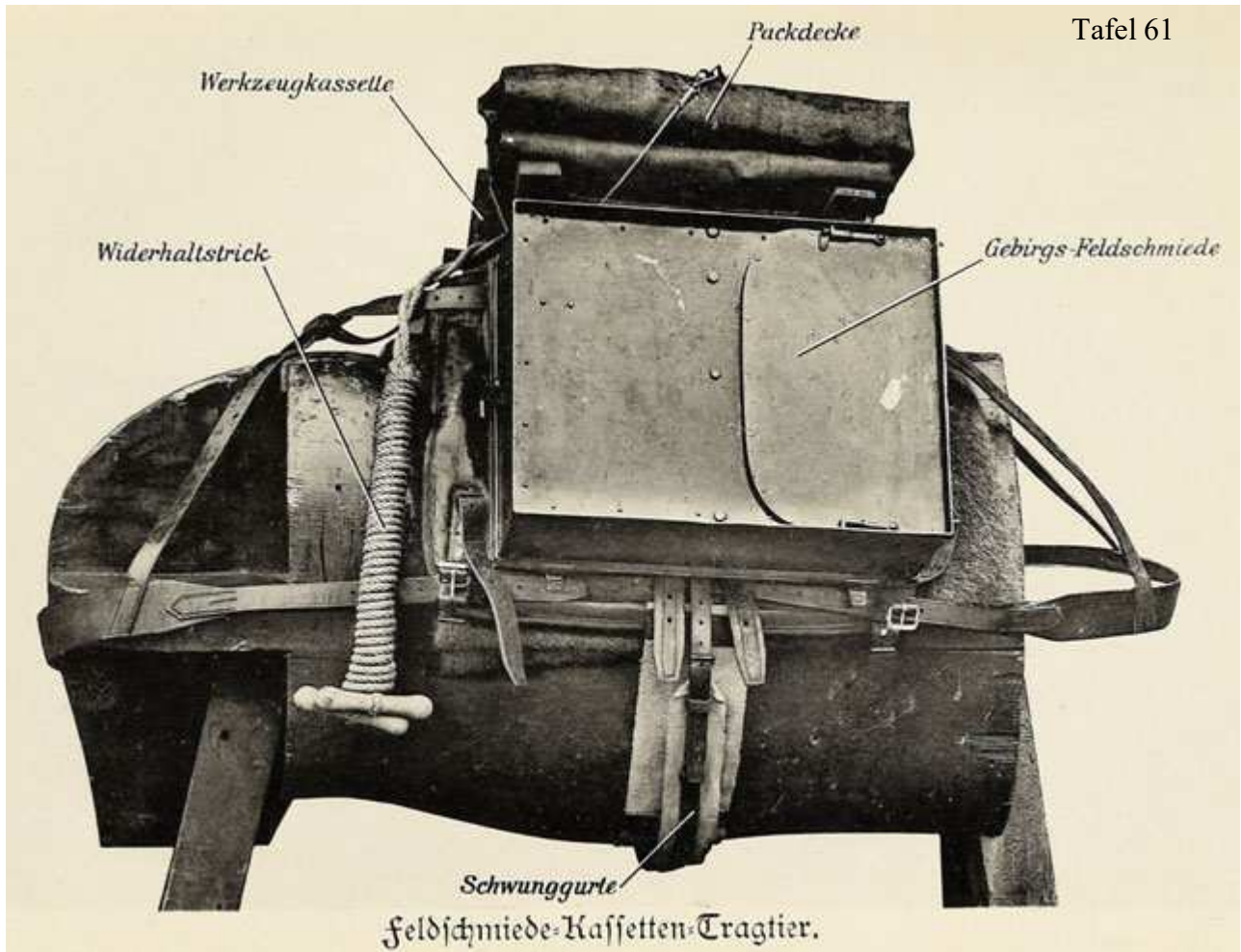

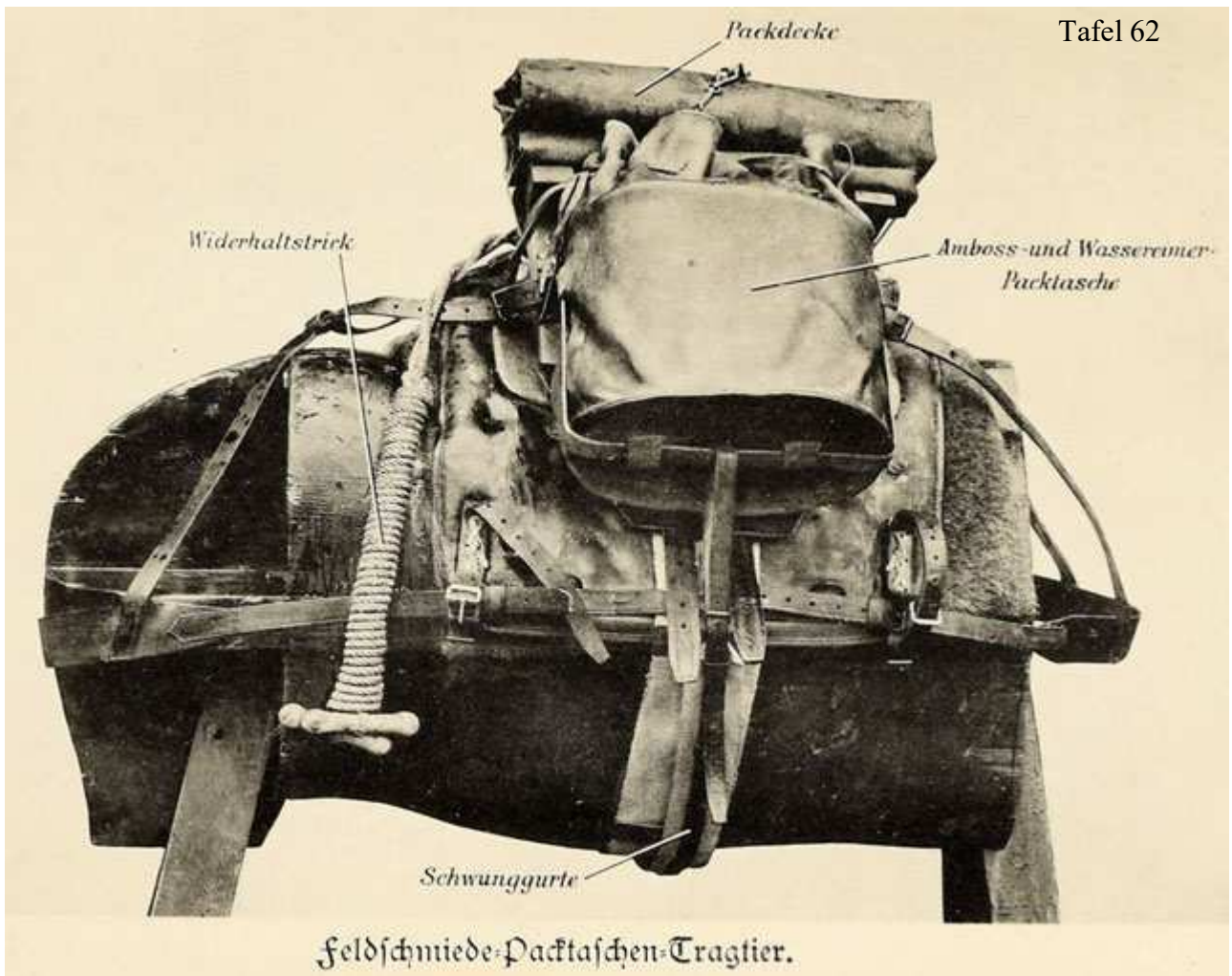

feldschmiede-Packtaschen-Tragtier.

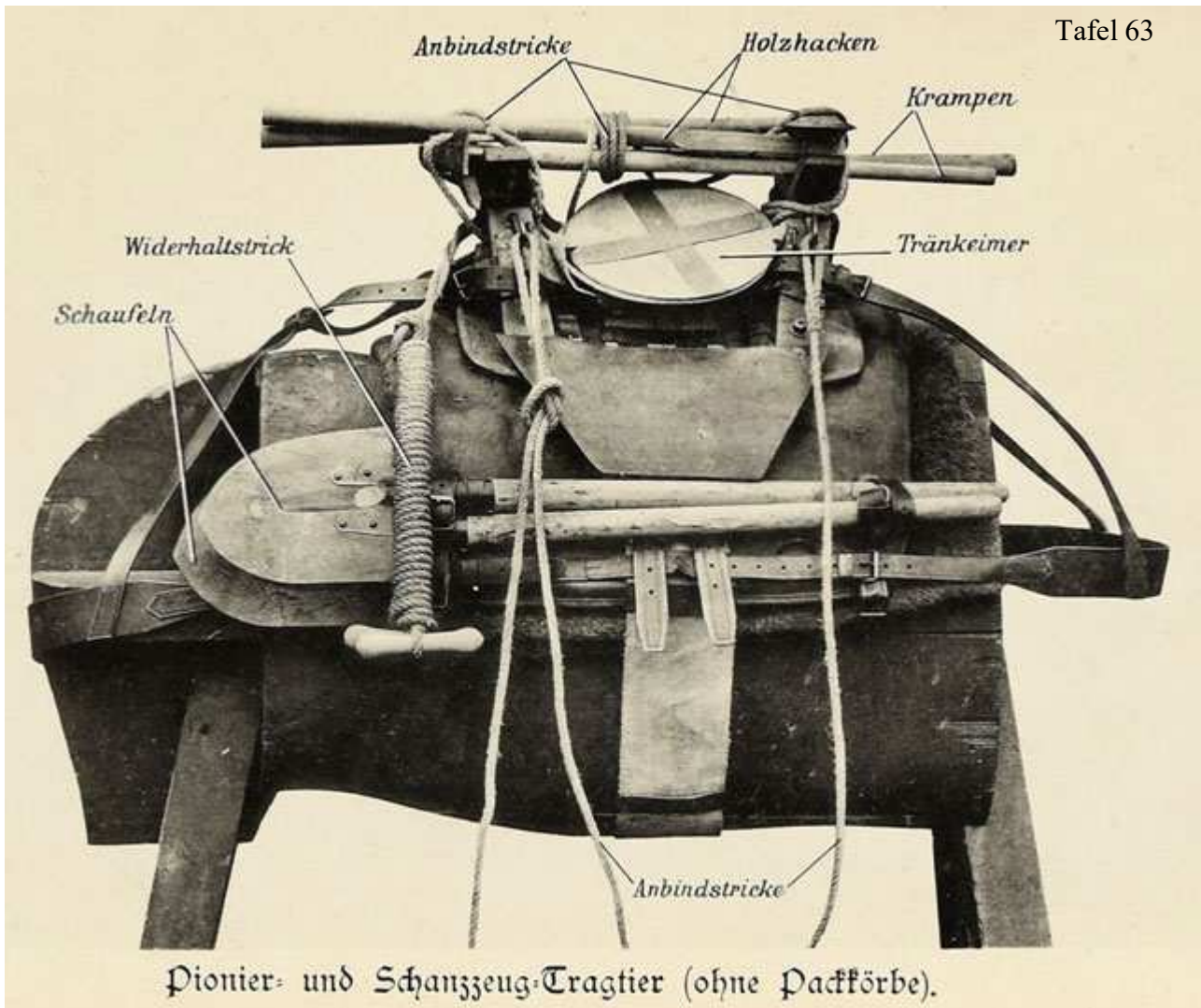

Pionier- und Schanzzeug-Tragtier (ohne Packkörbe).





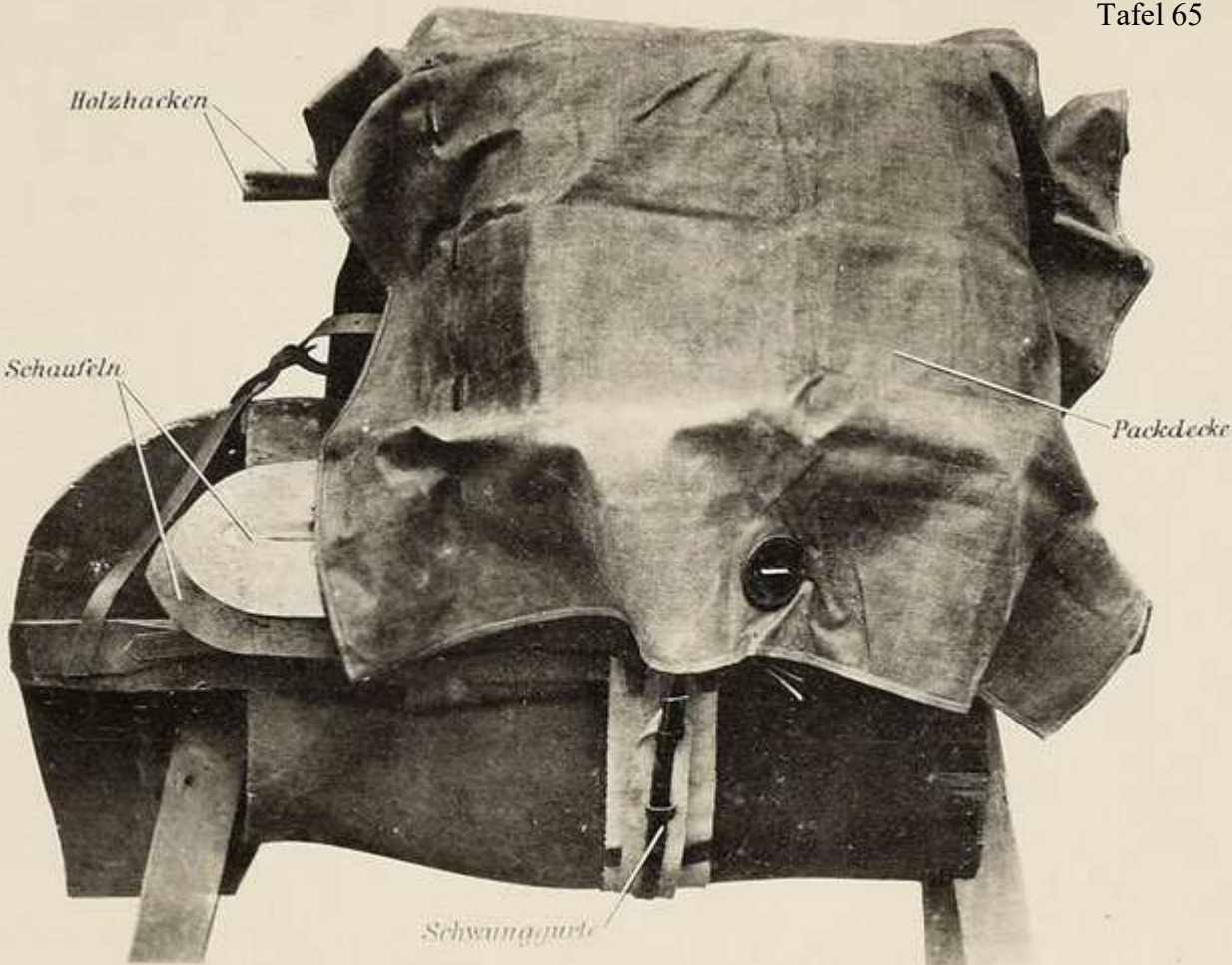

Pionier- und Schanzzeug-Tragtier (Packladung zugedeckt).

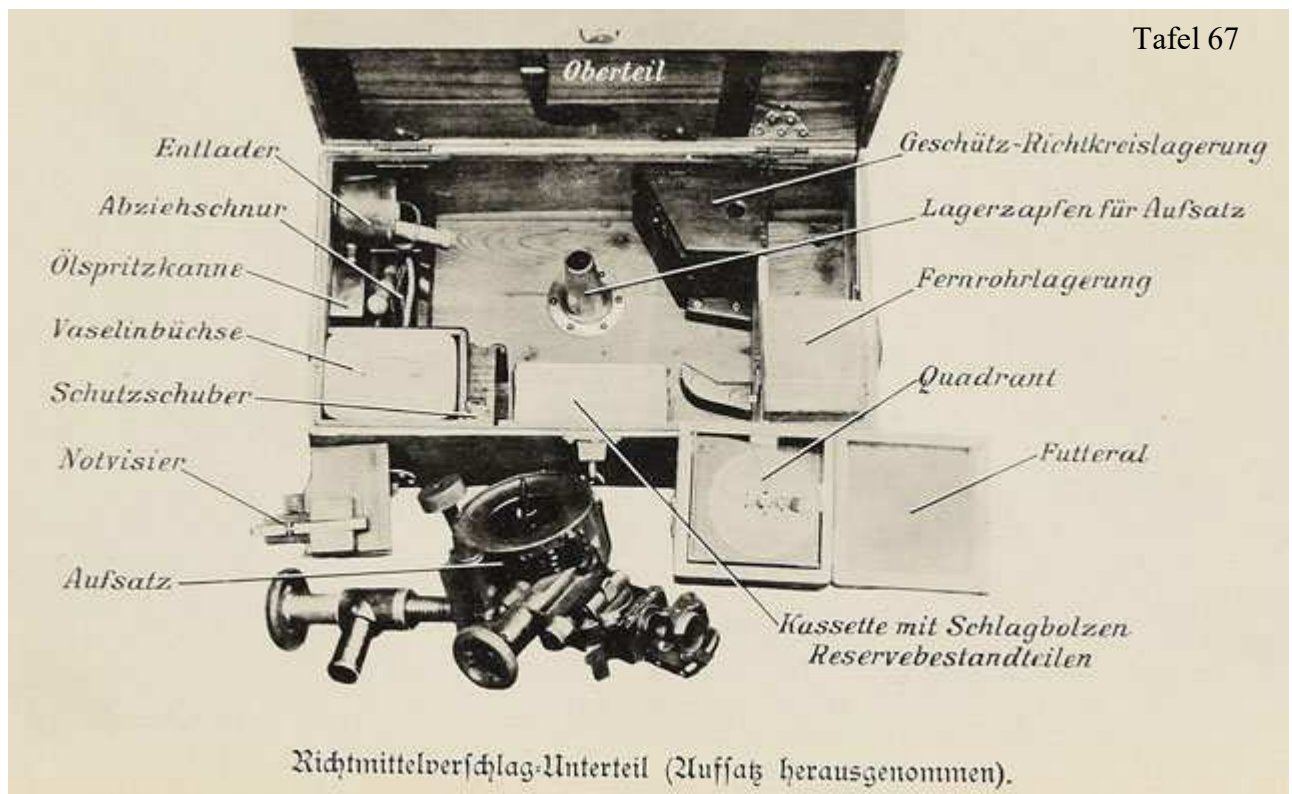
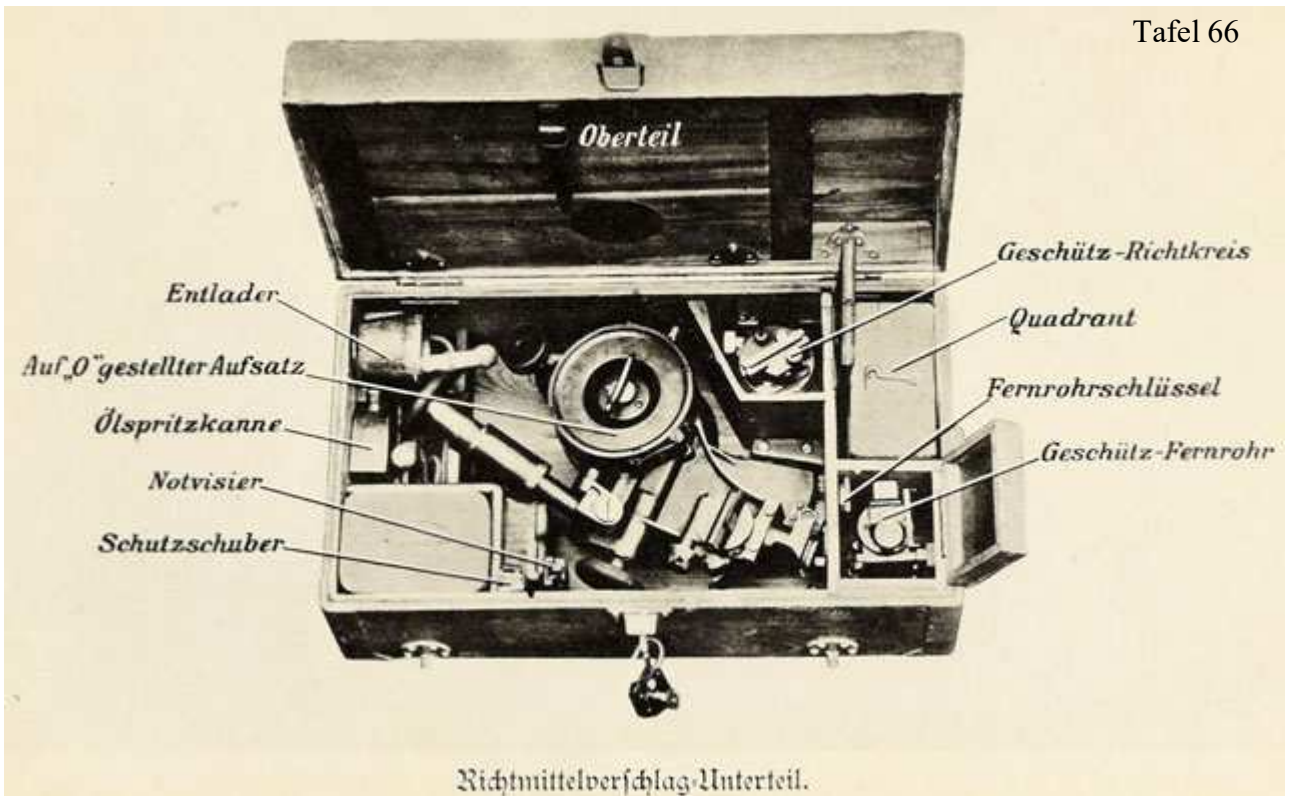

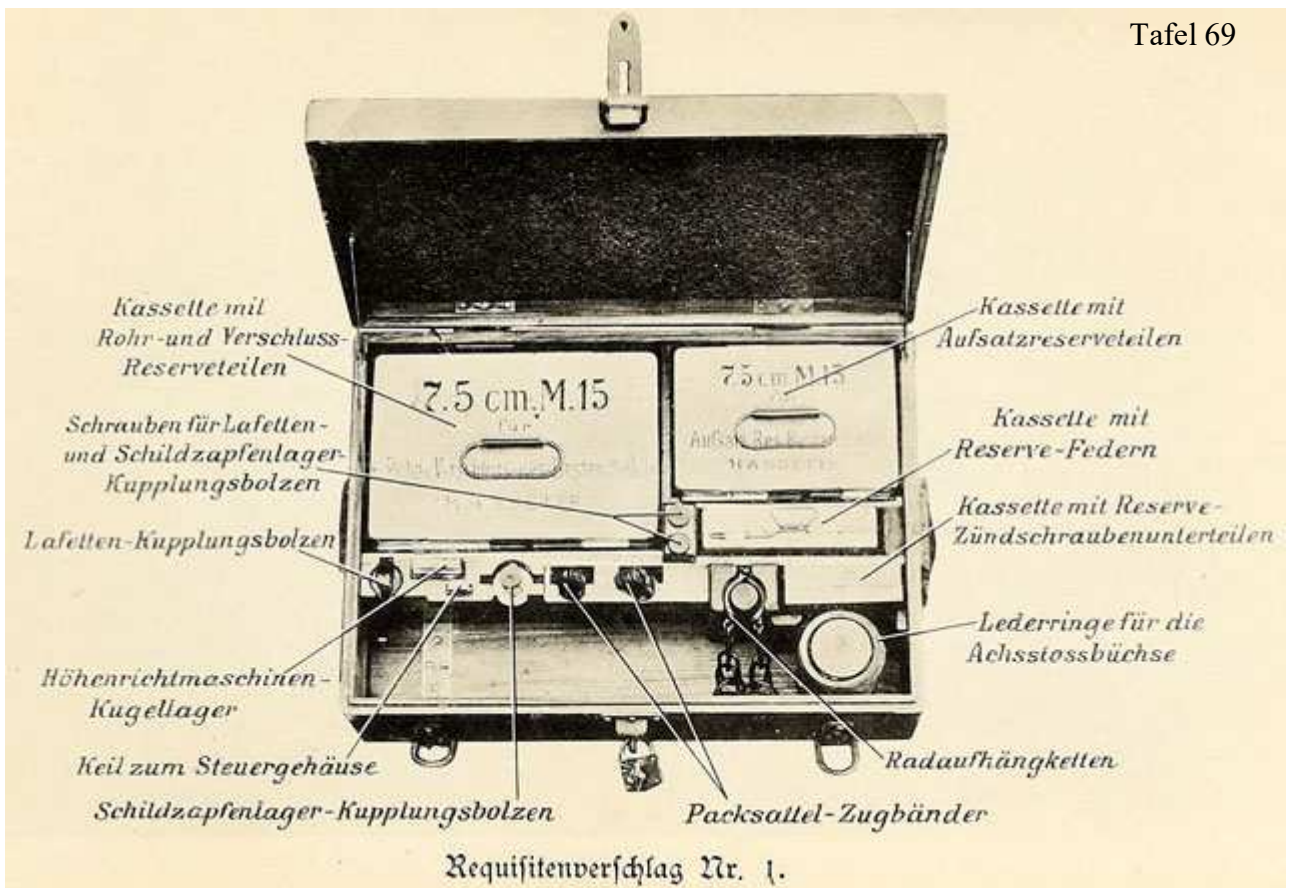
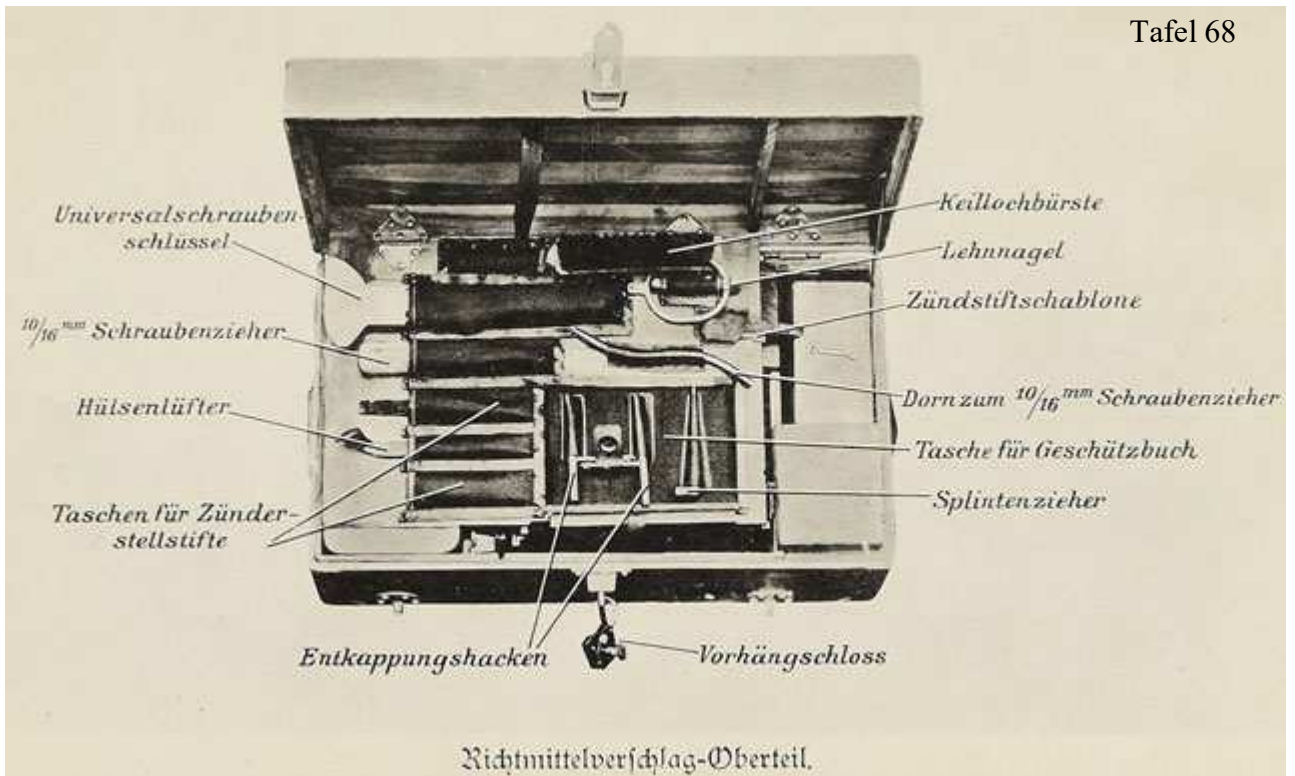

*Rohr-und Verschluss -  
Reserve-Bestandteile*

*Reserve - Federn*

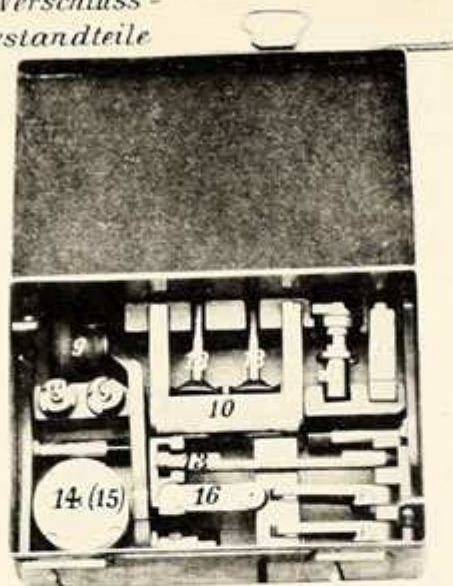
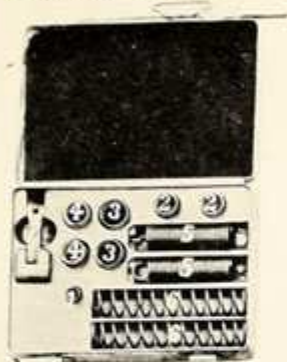

*Aufsatz - Reserveteile*

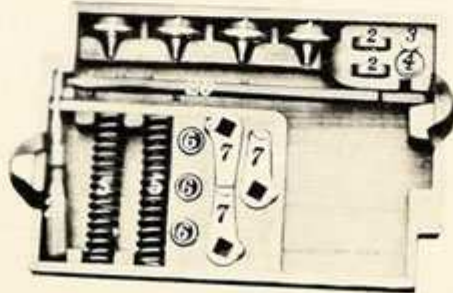
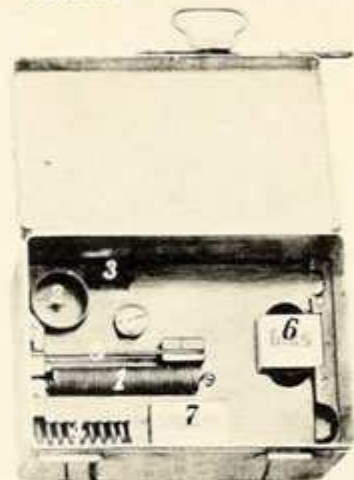

*Einsatz*

*Einsatz*

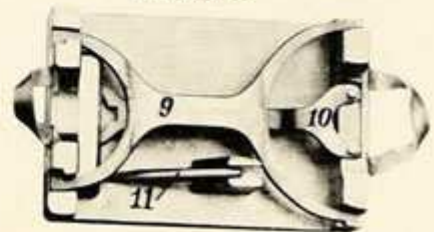

Requisitenverschlagn Nr. 1 (Inhalt der Kassetten).

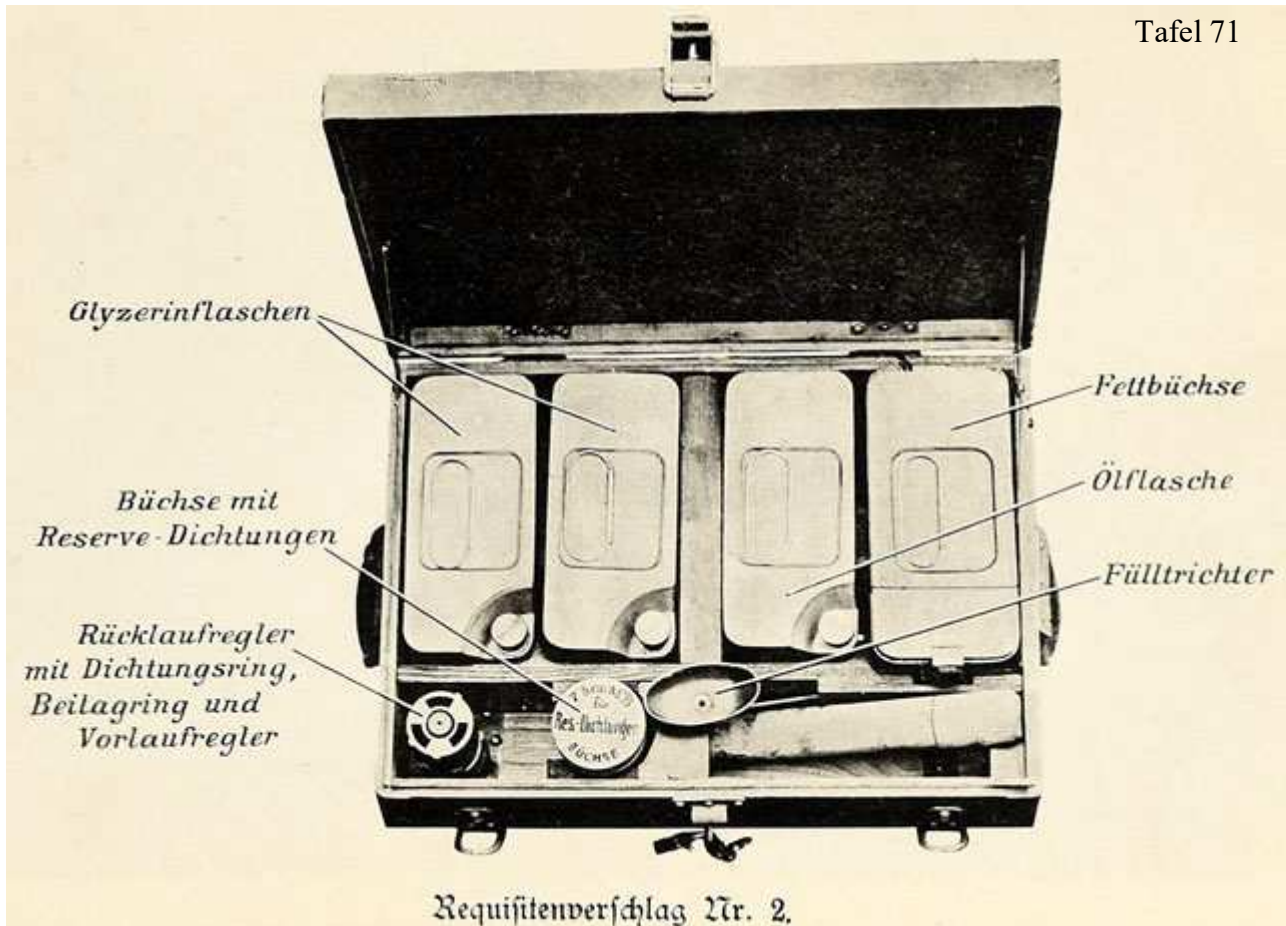

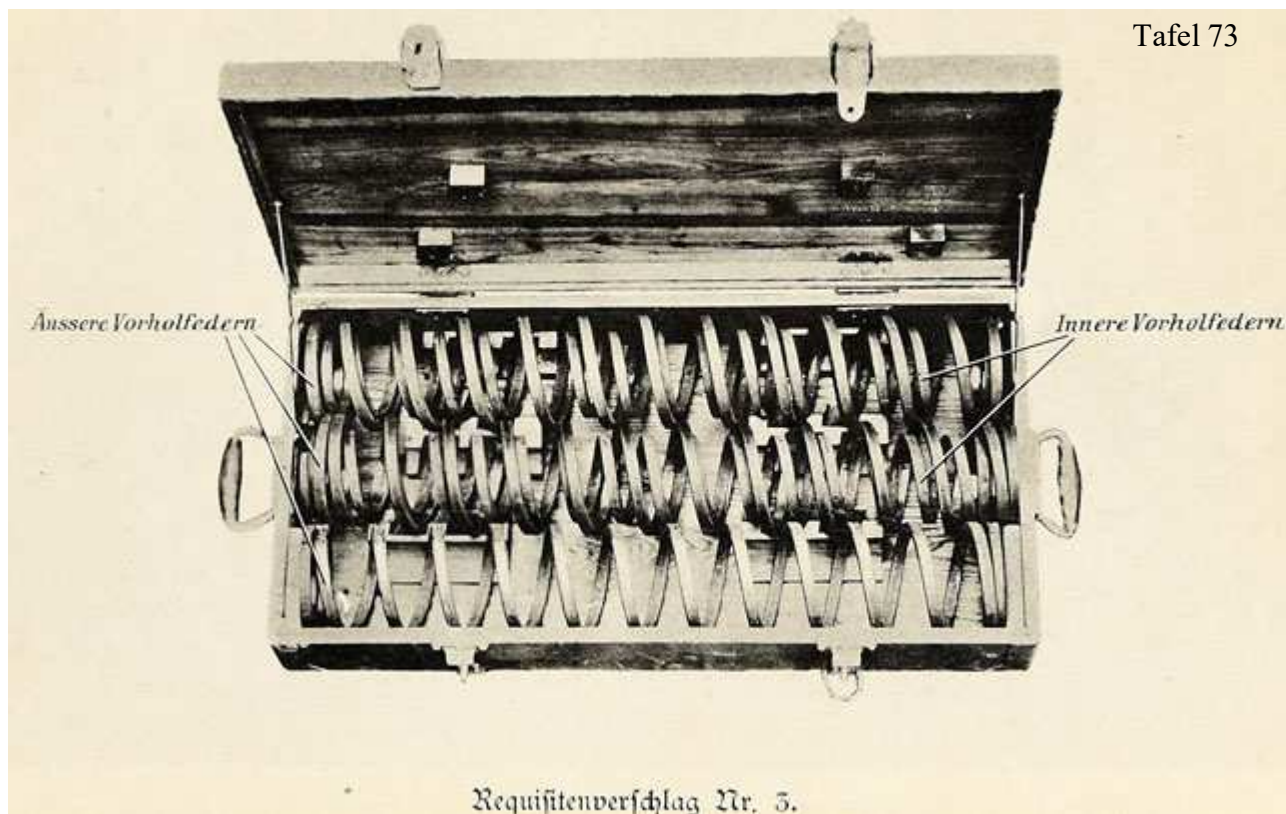
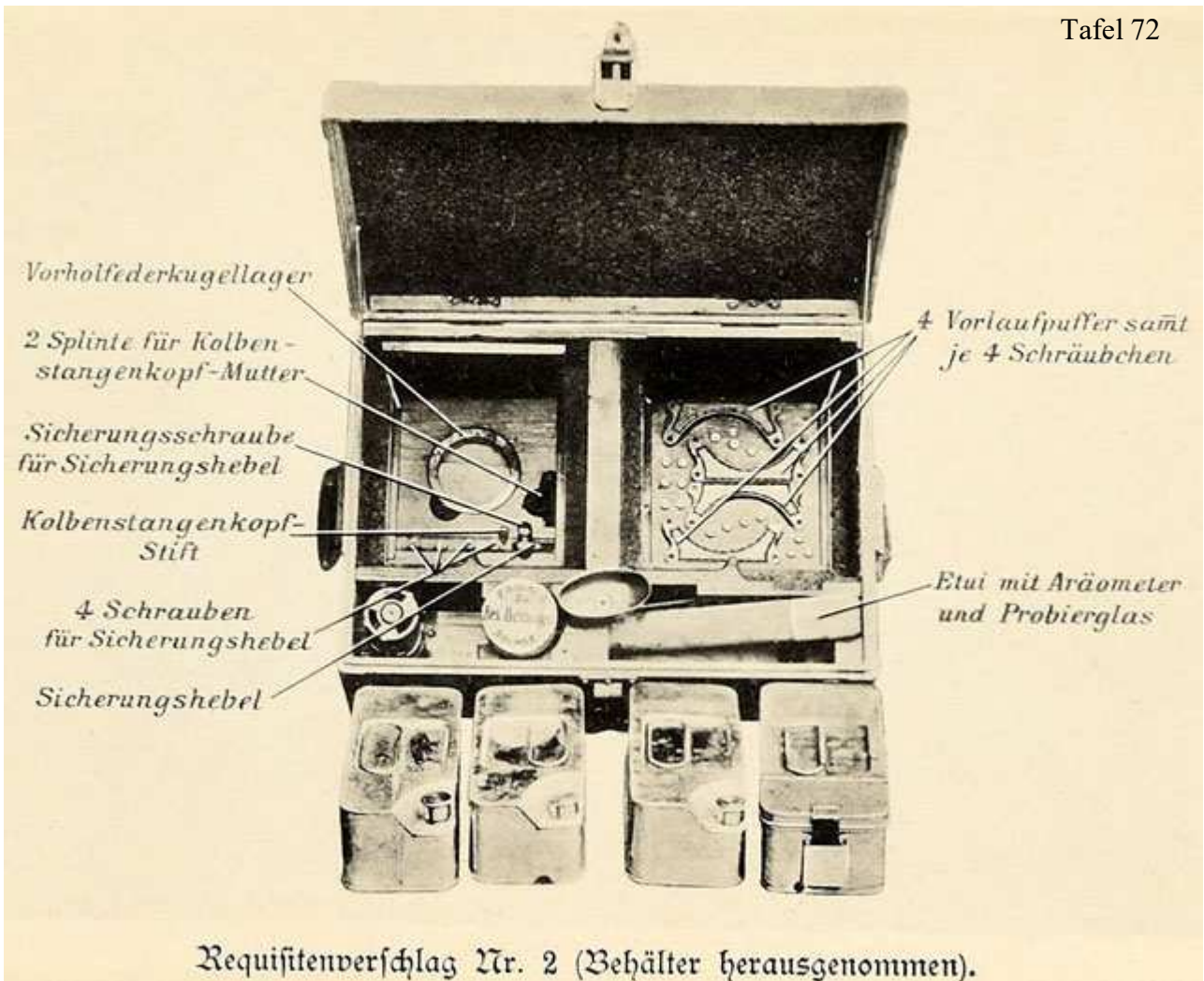

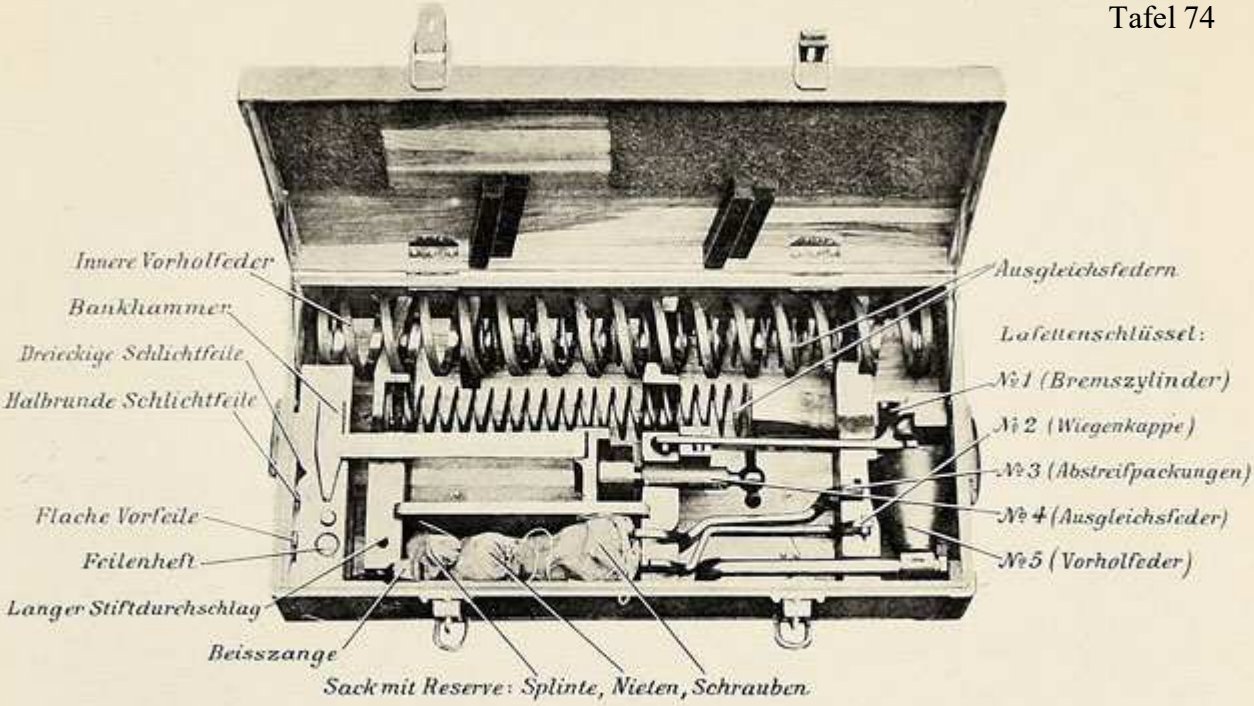

Requisitenverschlag Nr. 4.

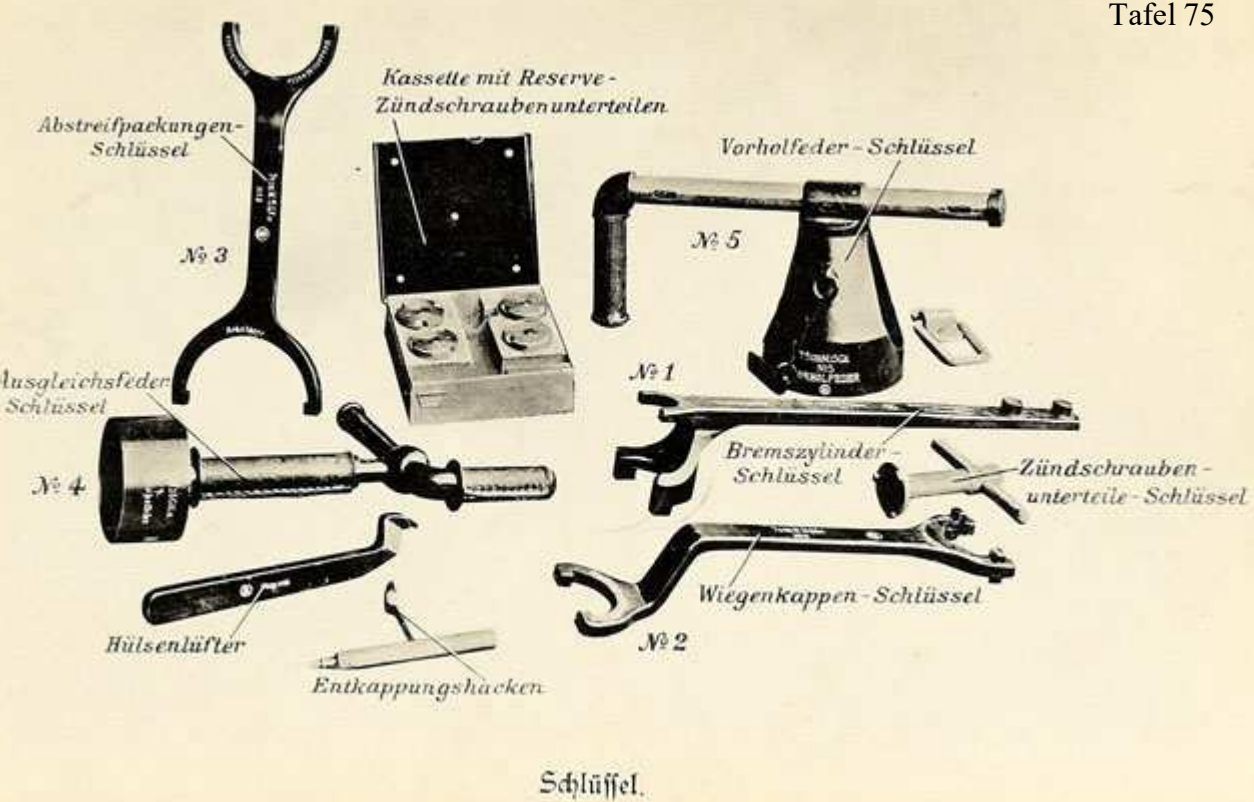

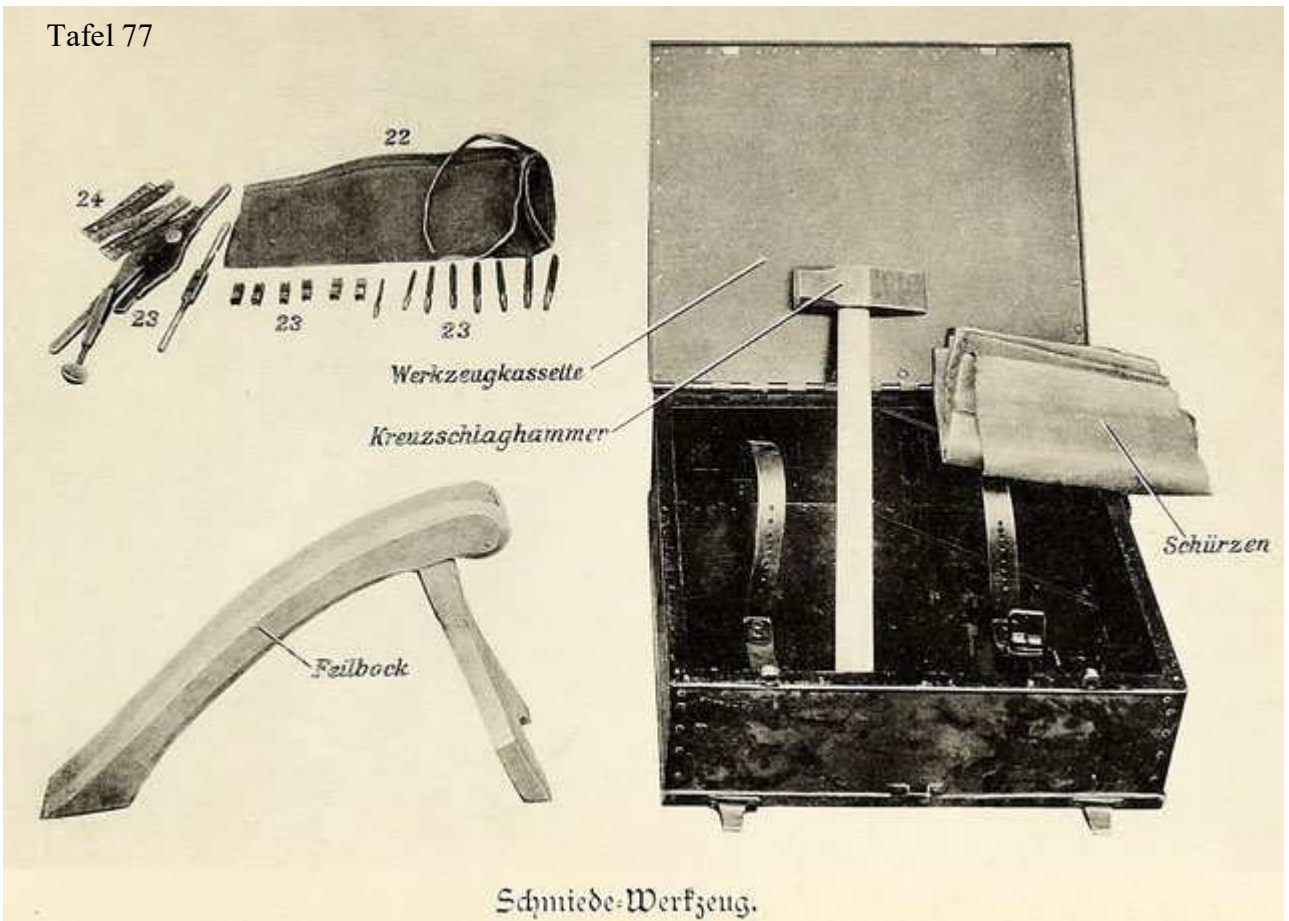
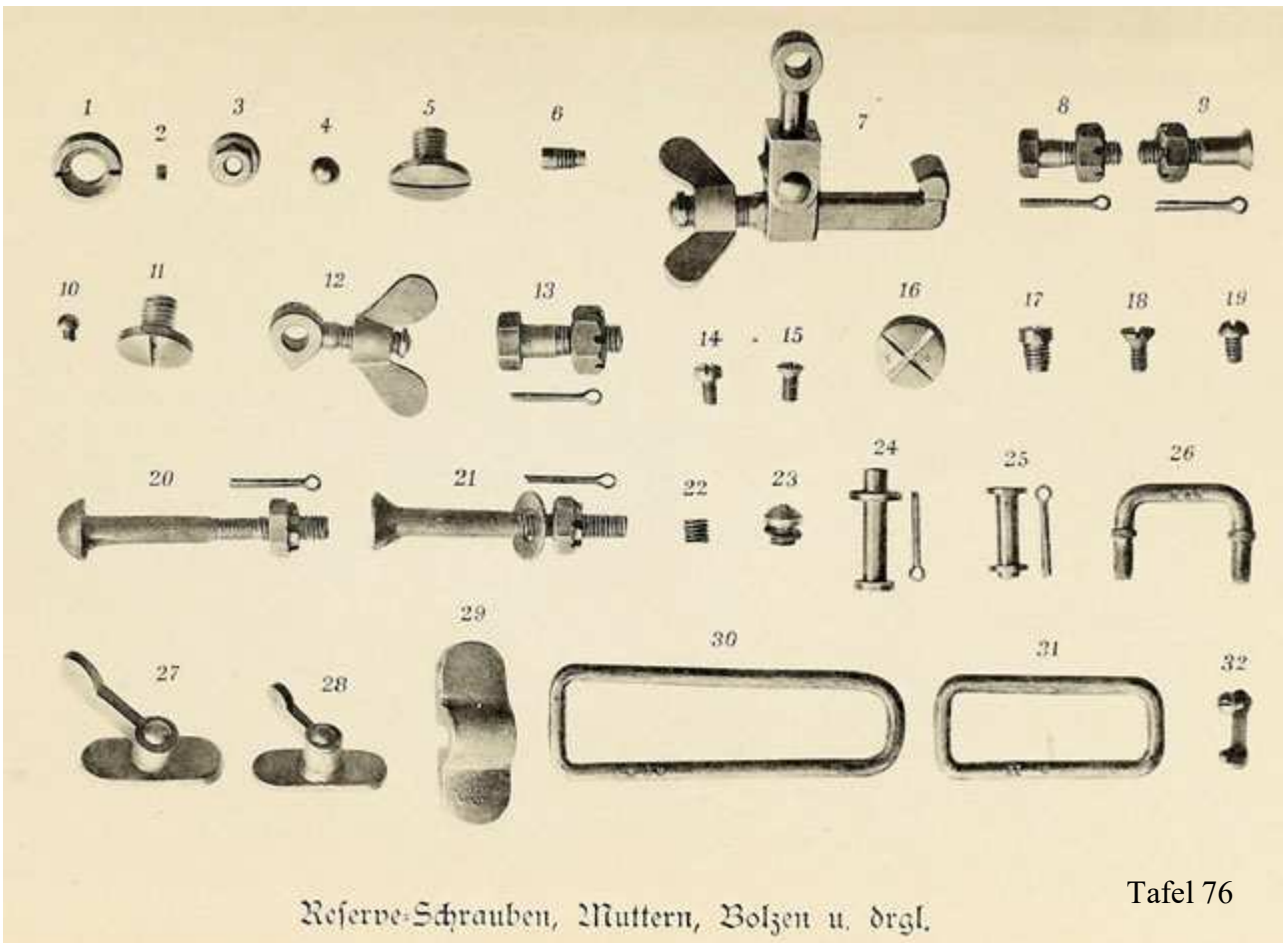



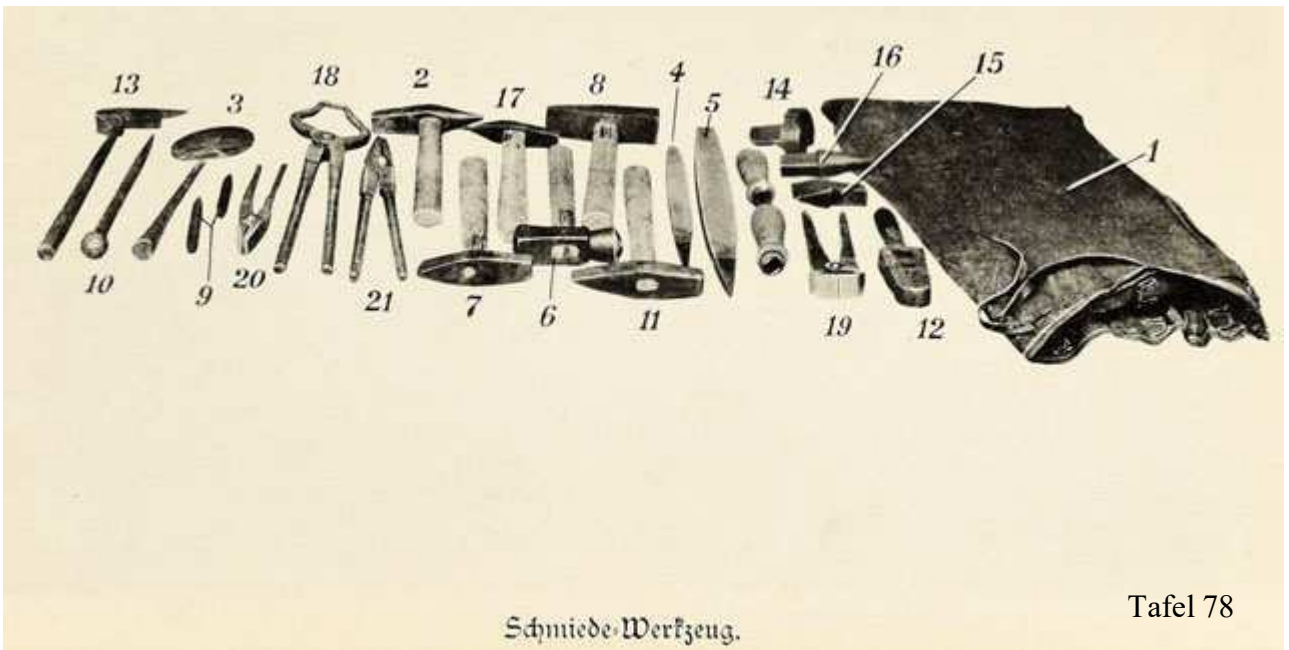

Schmiede-Werkzeug.

Tafel 78

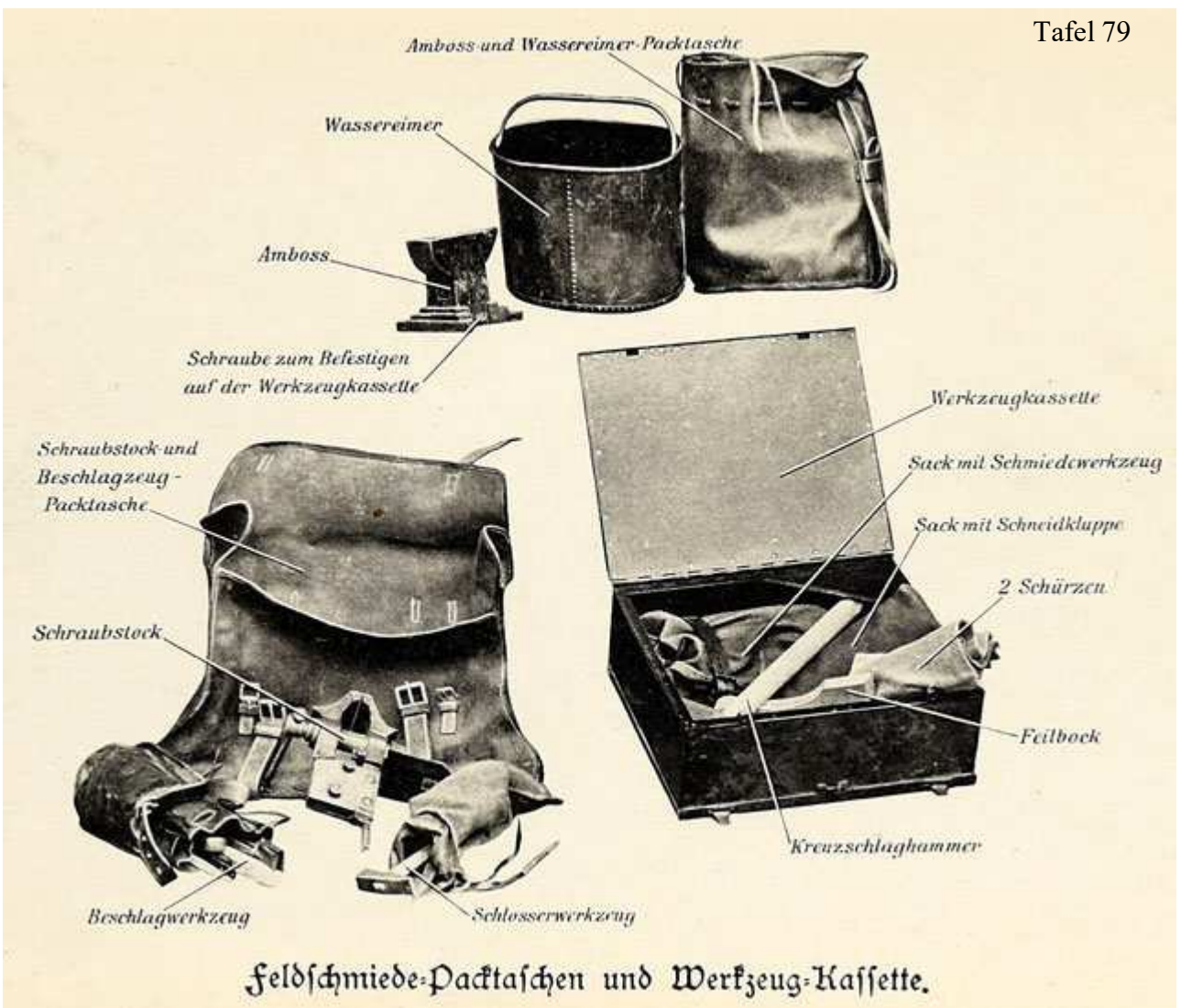

Feldschmiede-Packtaschen und Werkzeug-Kassette.

Tafel 79

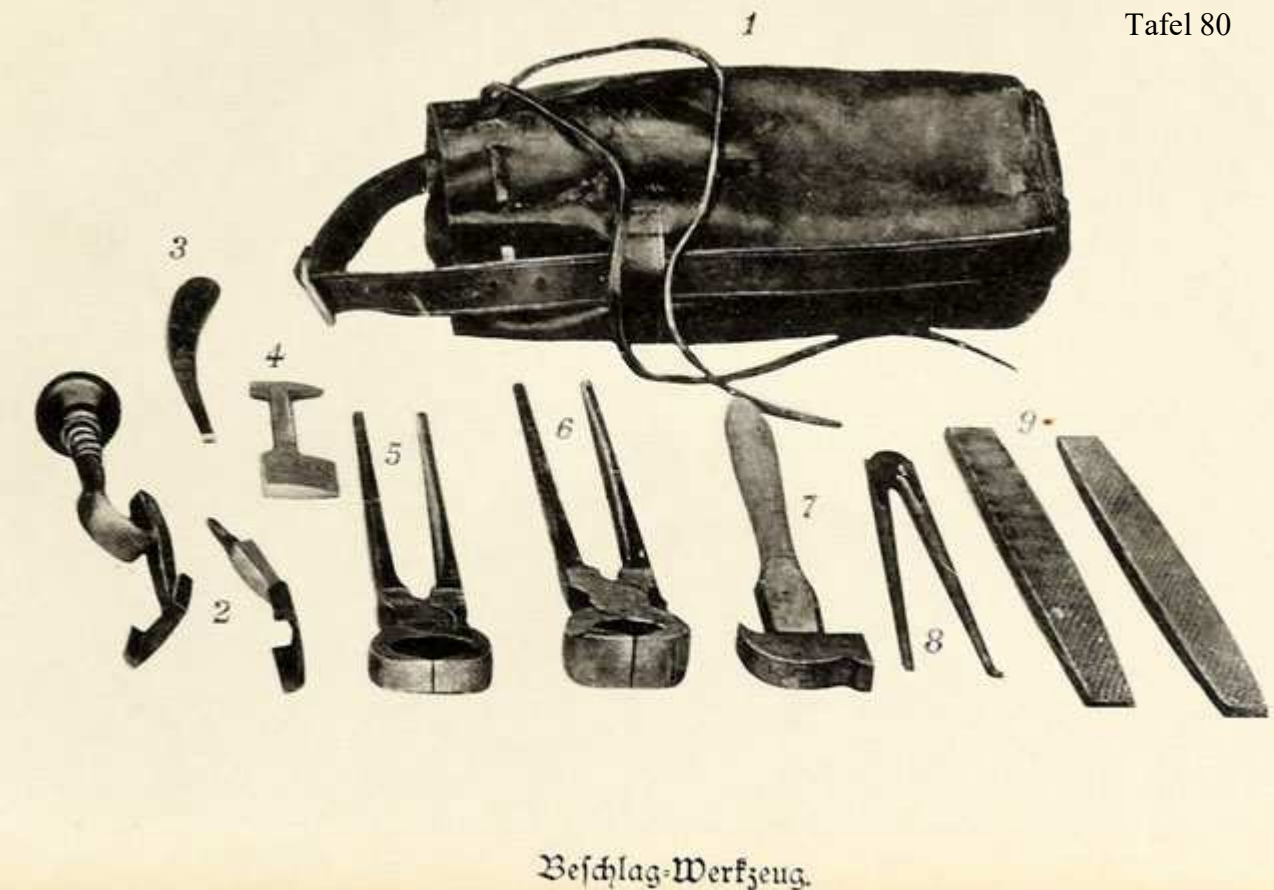

Beschlag-Werkzeug.

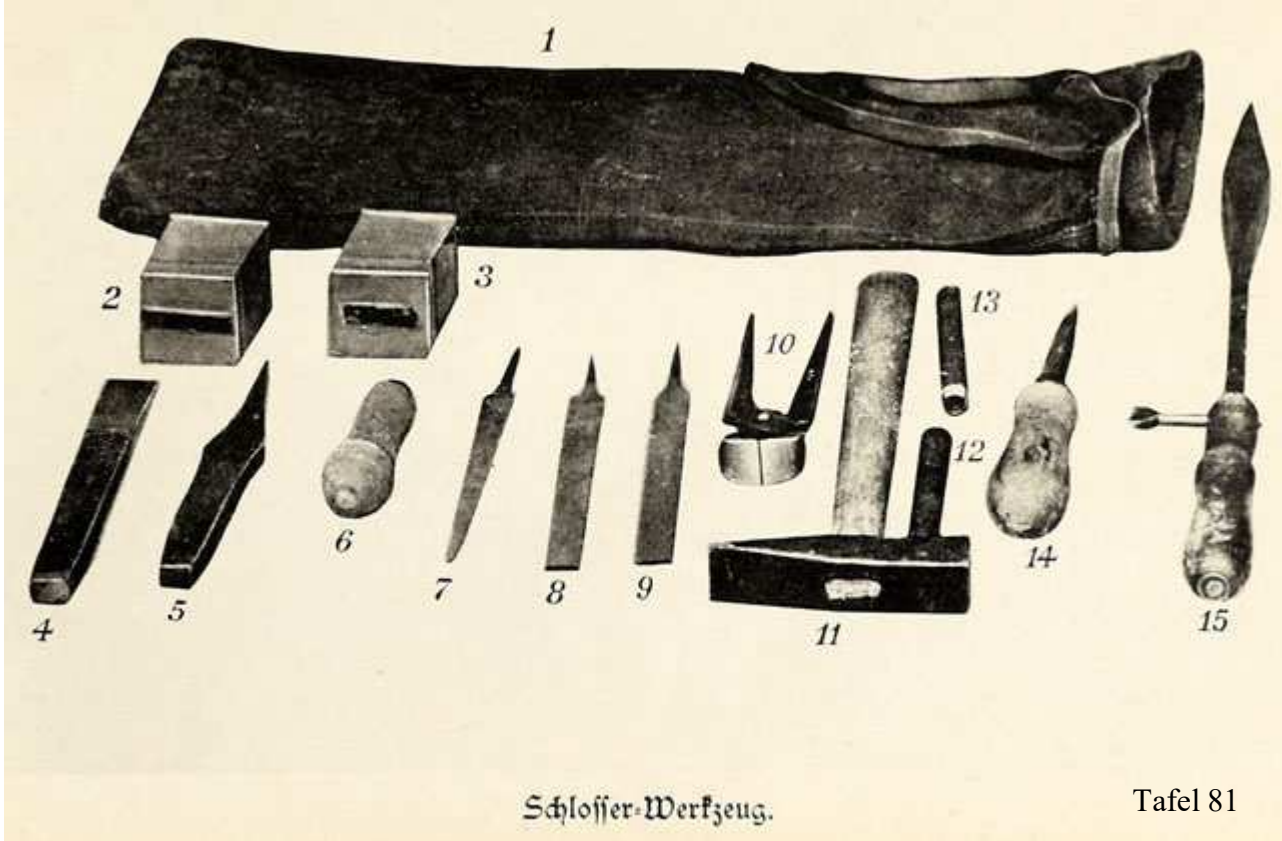

Schlosser-Werkzeug.

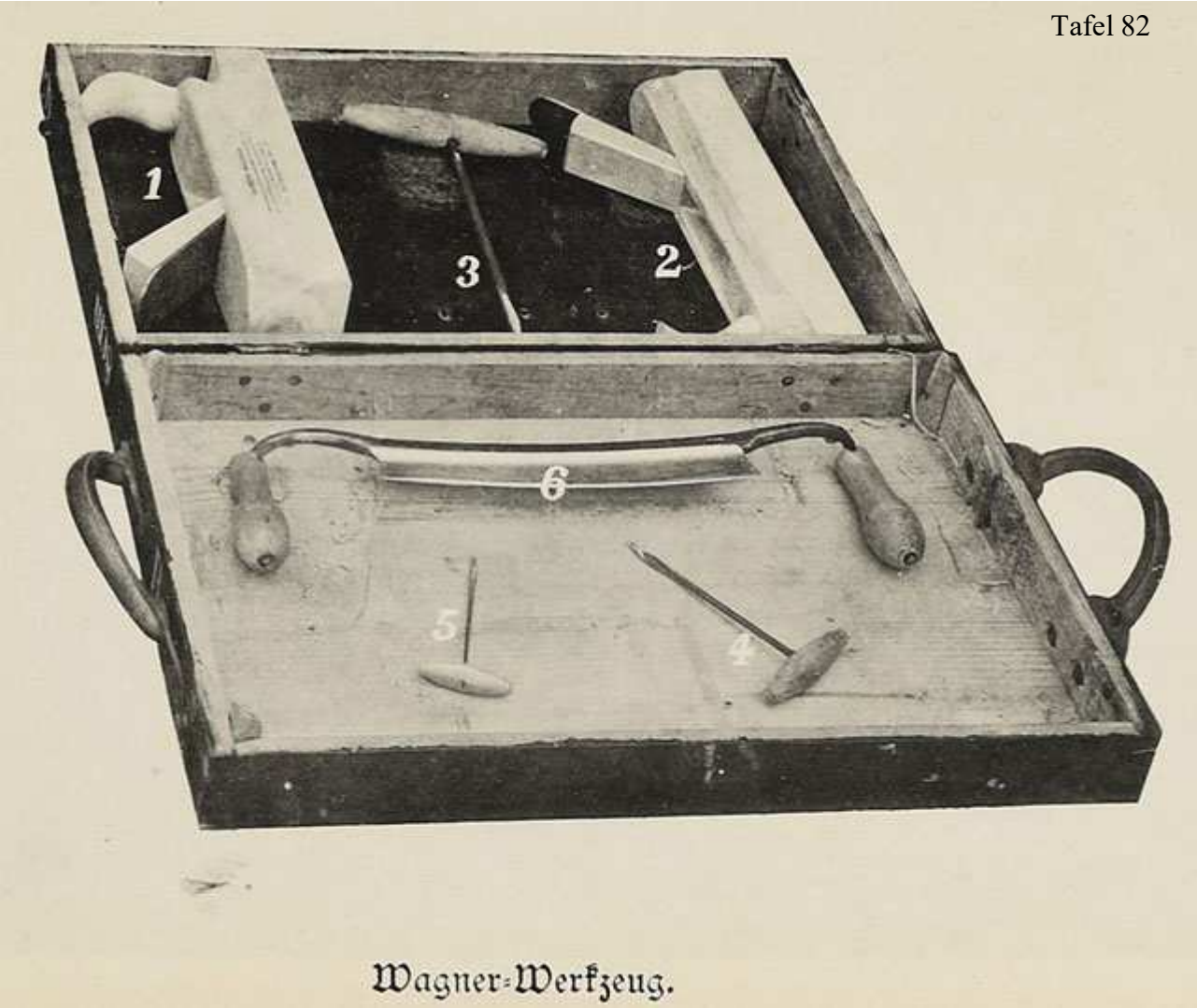

Wagner-Werkzeug.

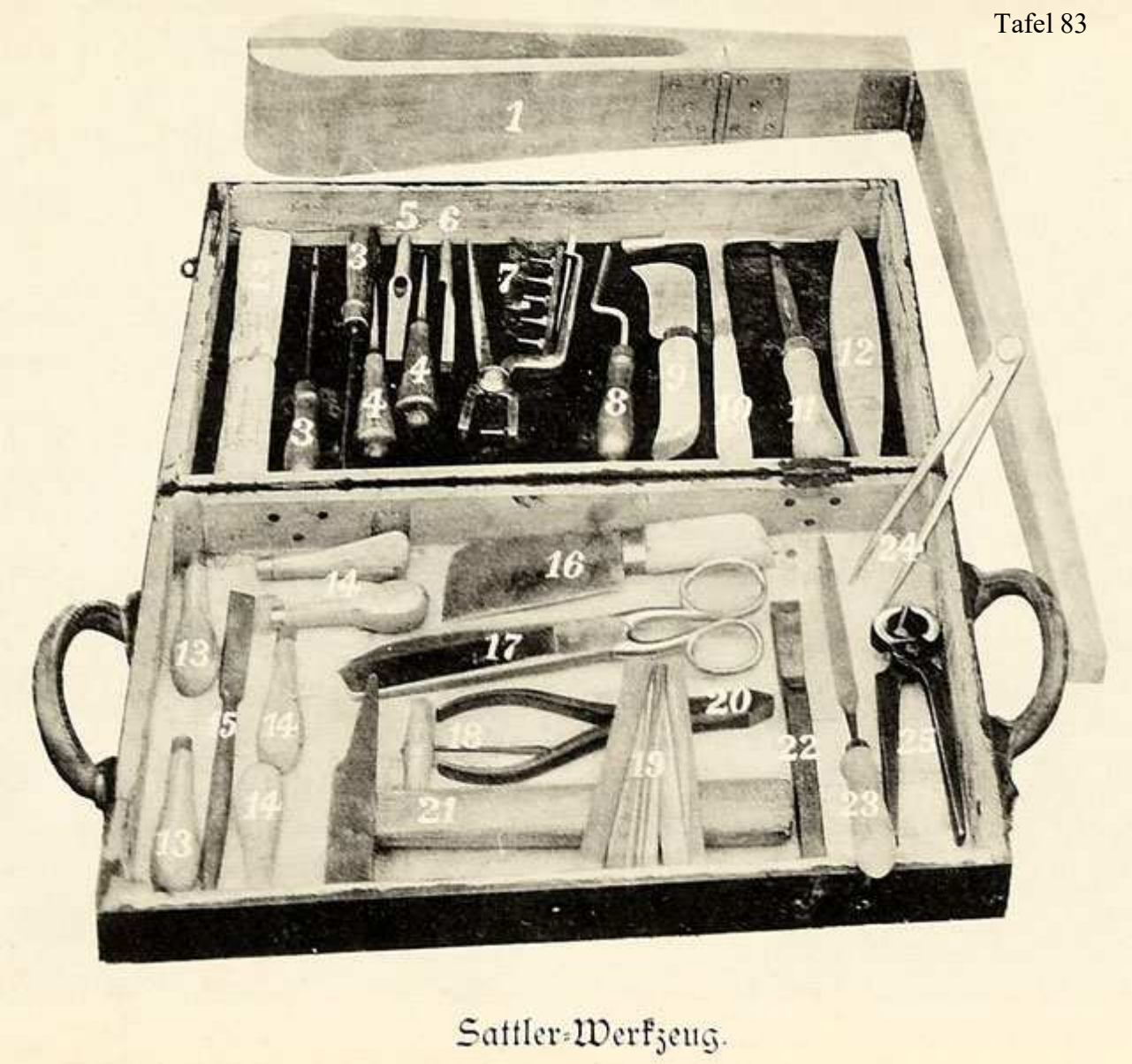

Sattler-Werkzeug.

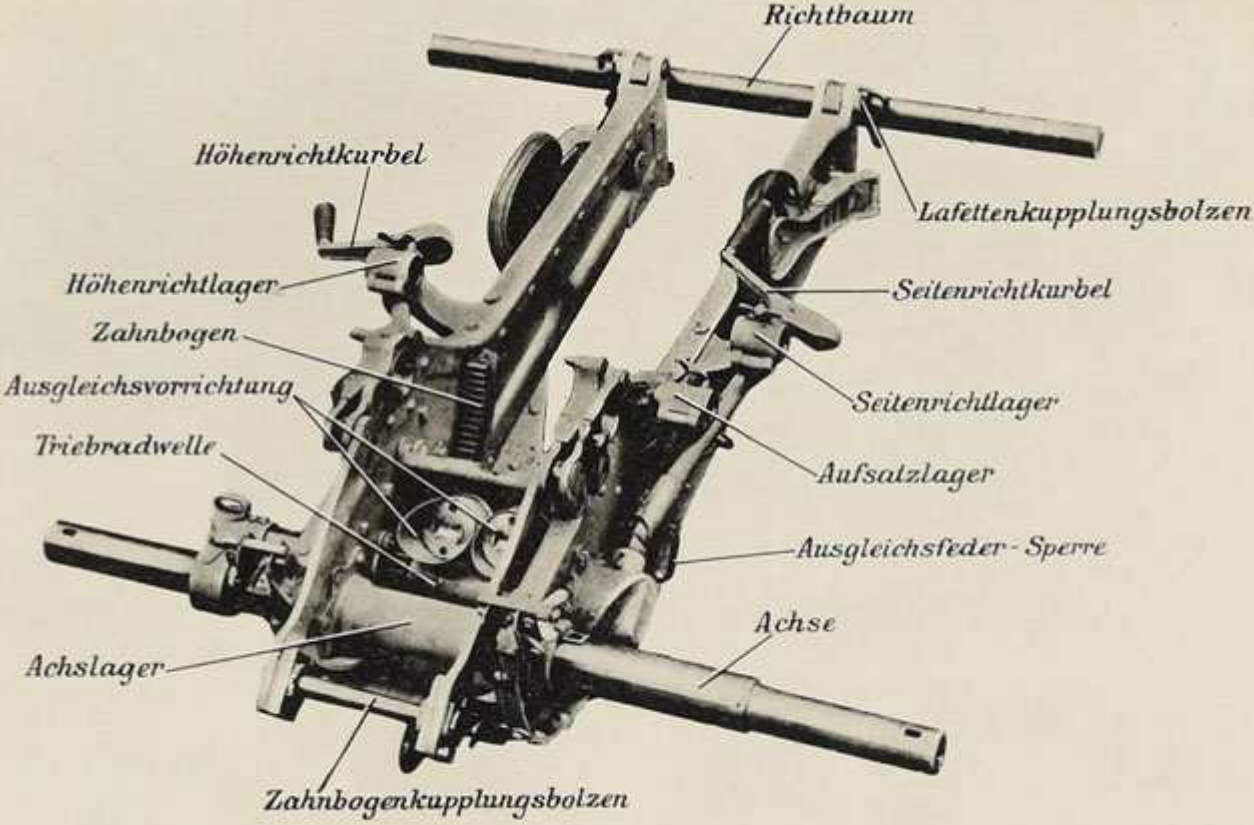

Vorderlafette mit Richtbaum.

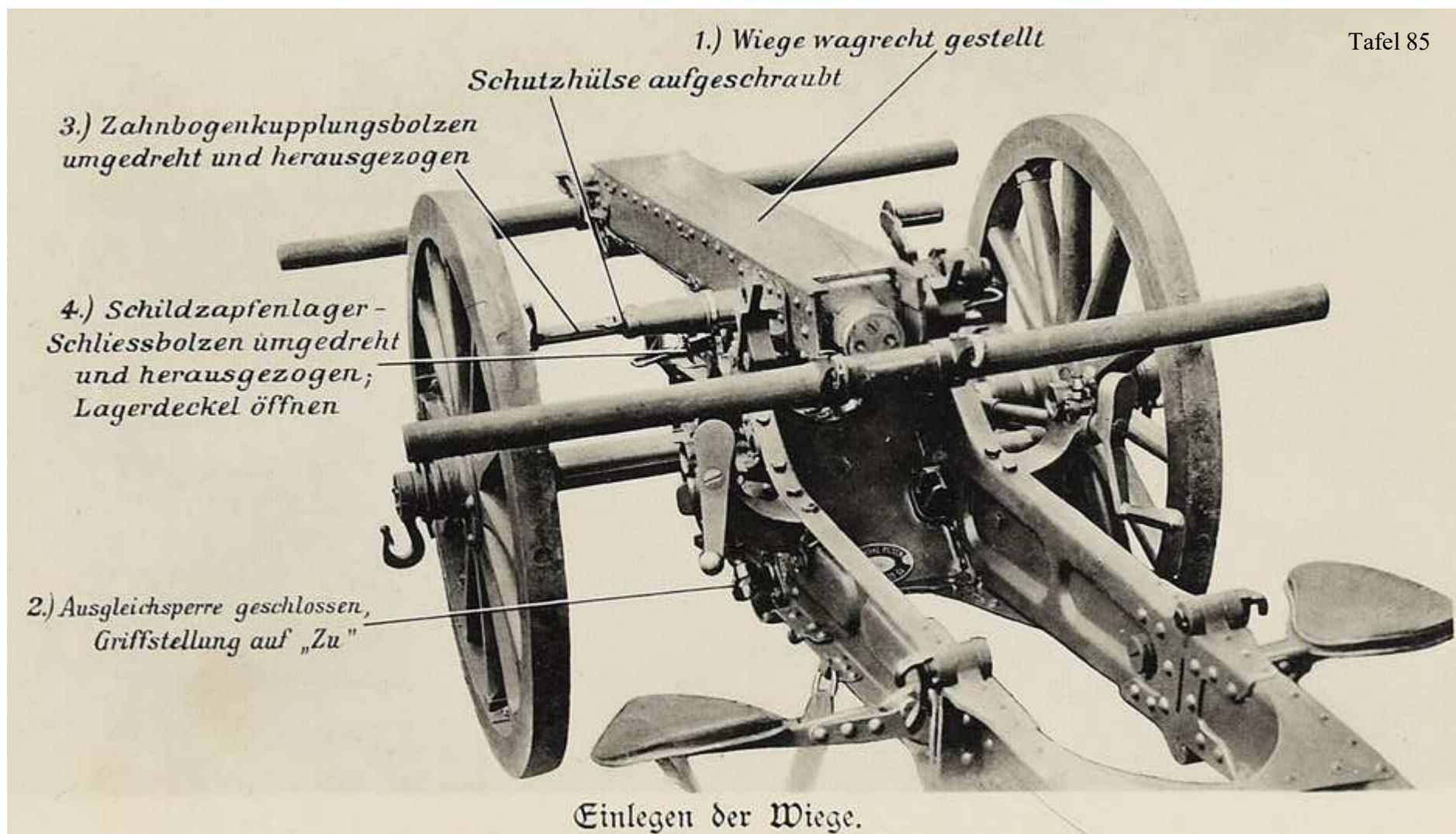

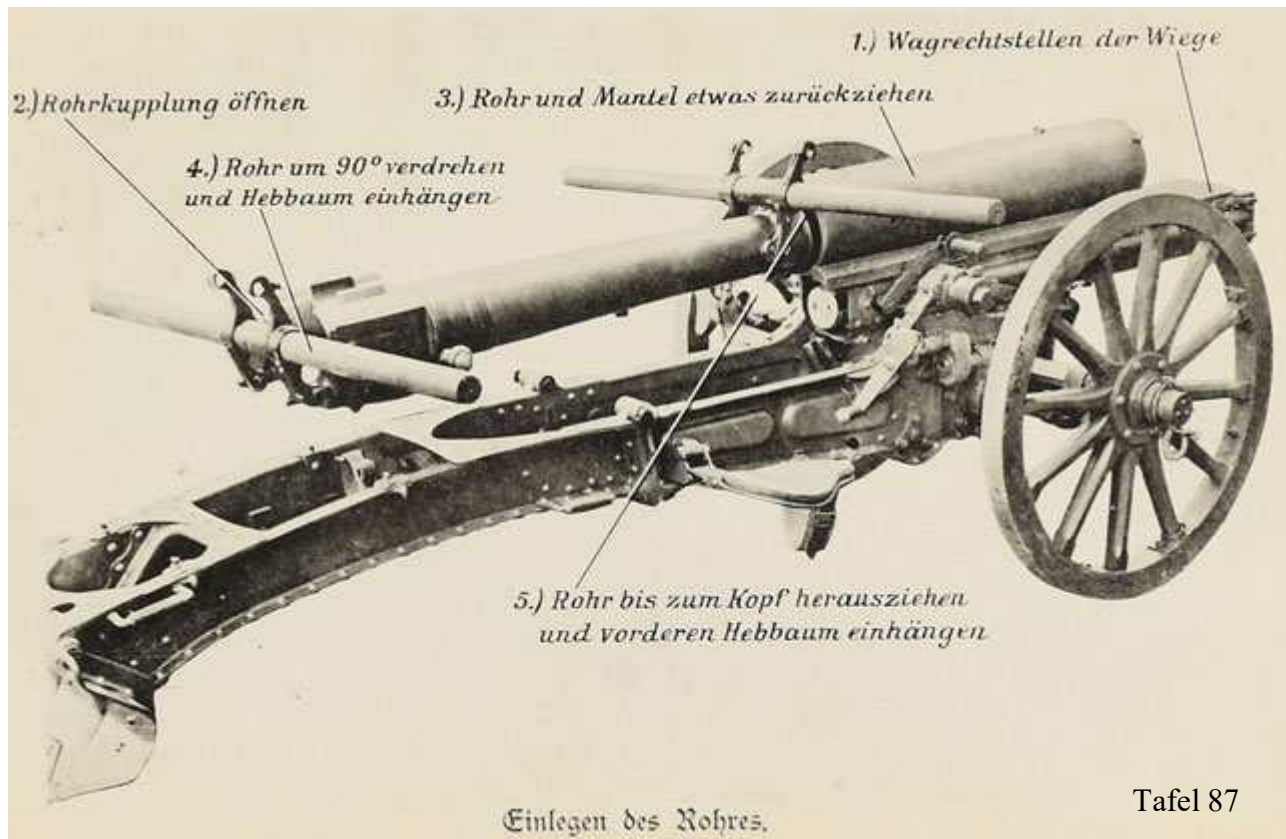
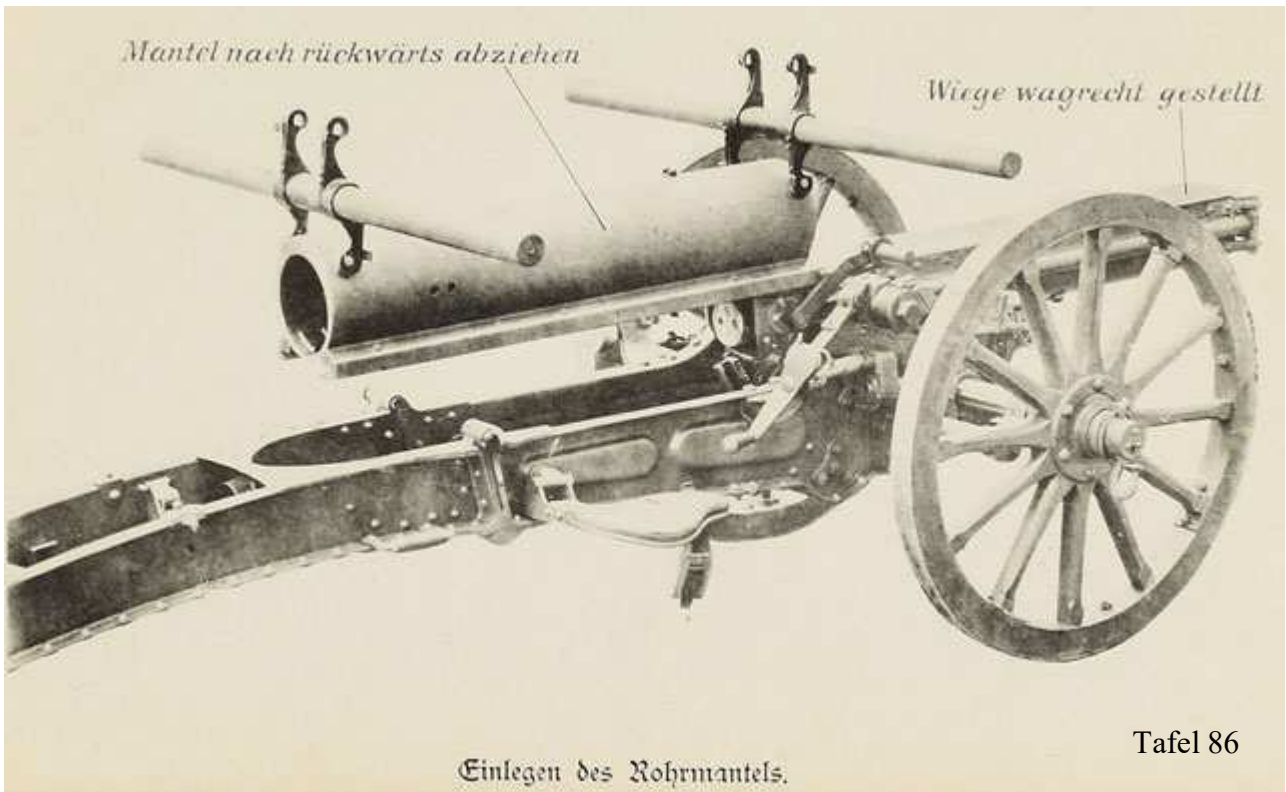

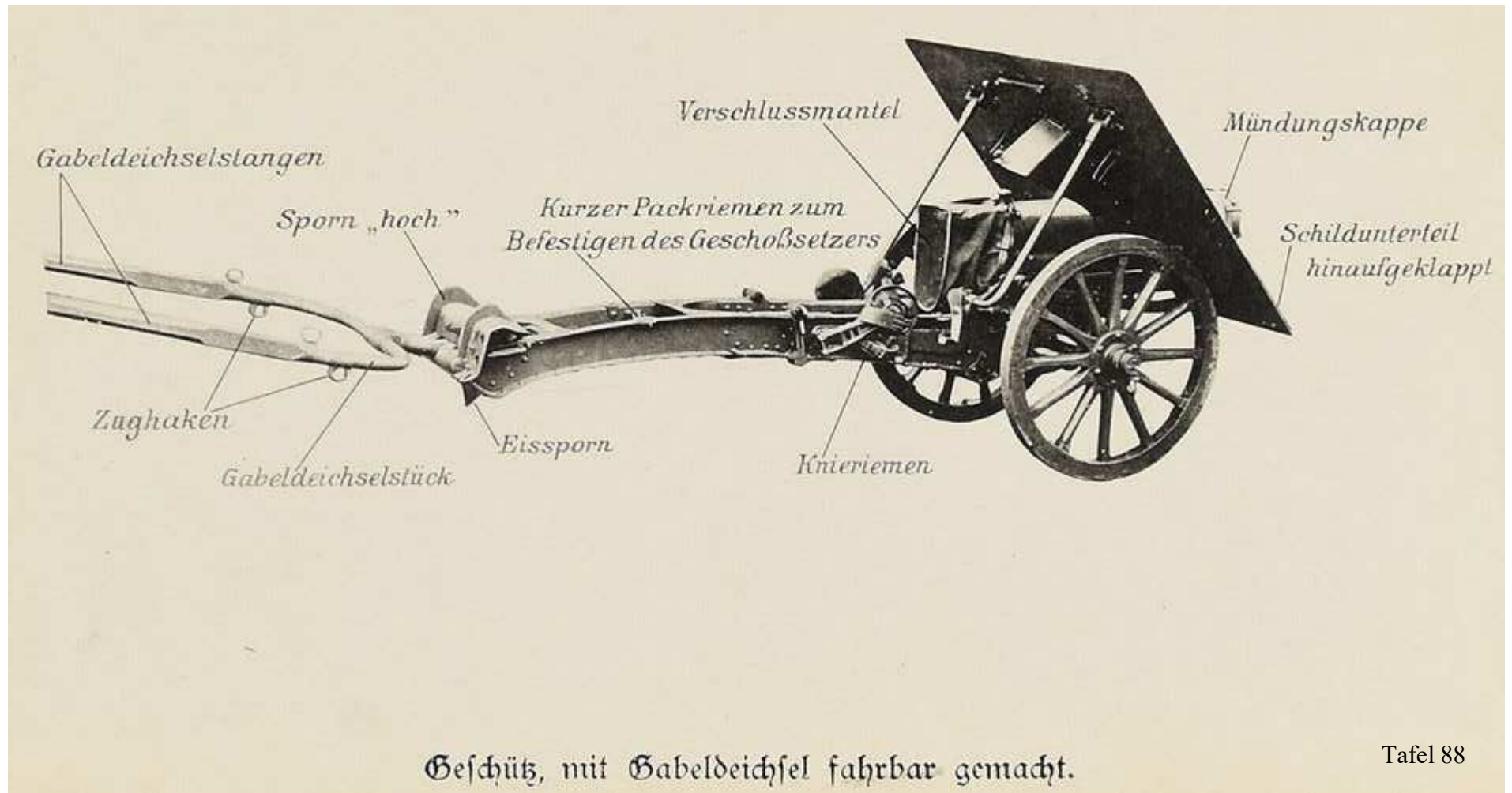



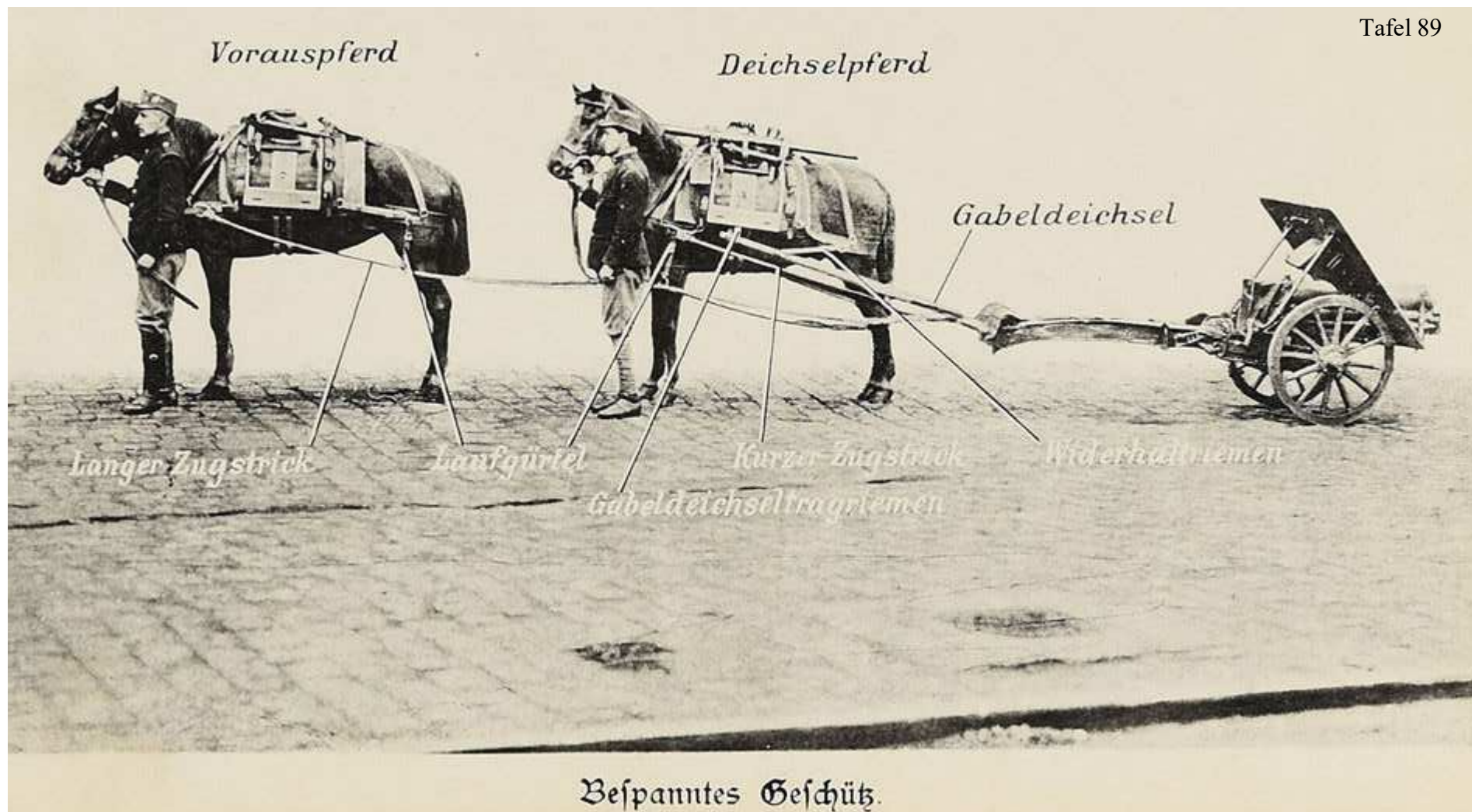

Tafel 90

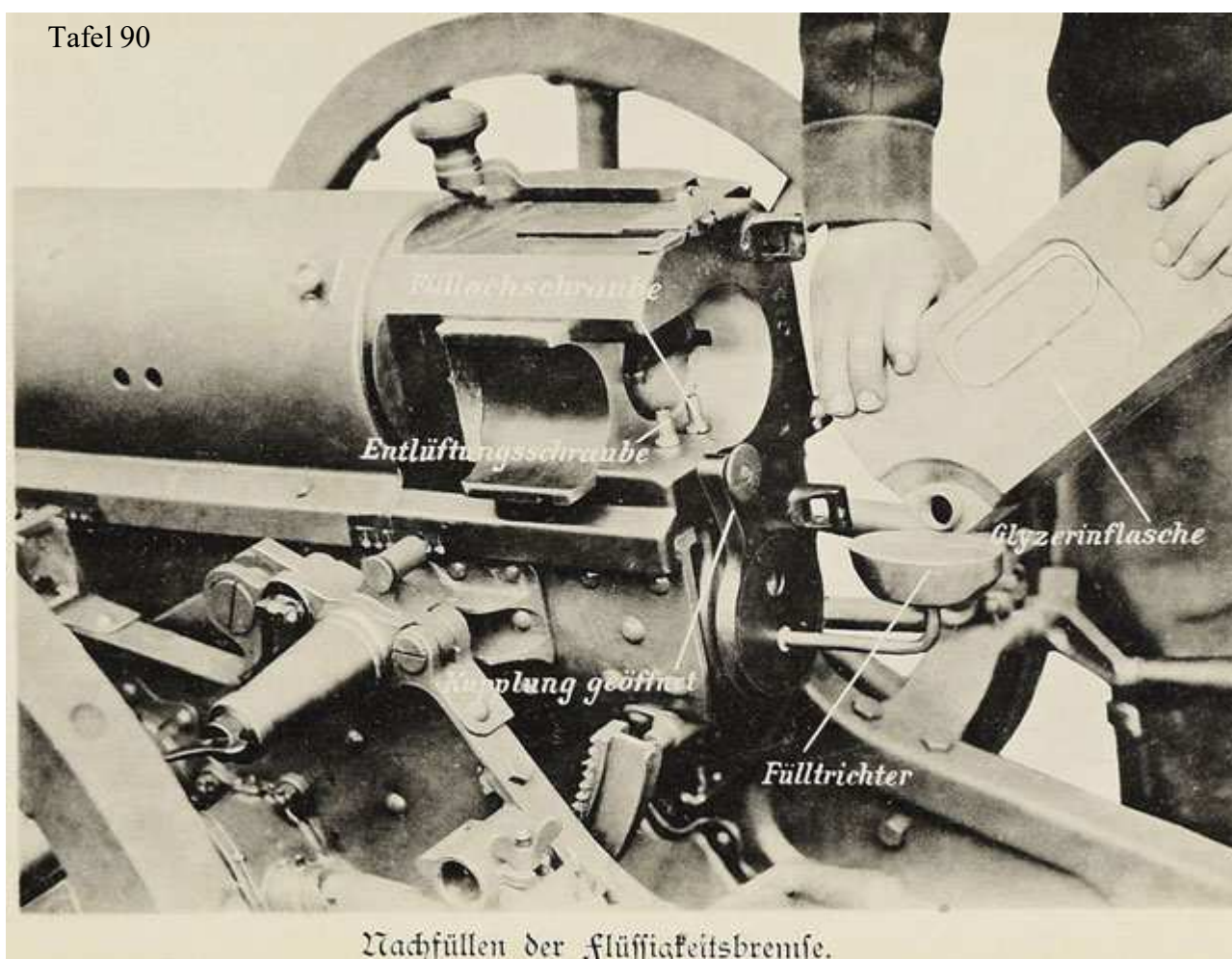

Nachfüllen der Flüssigkeitsbremse.

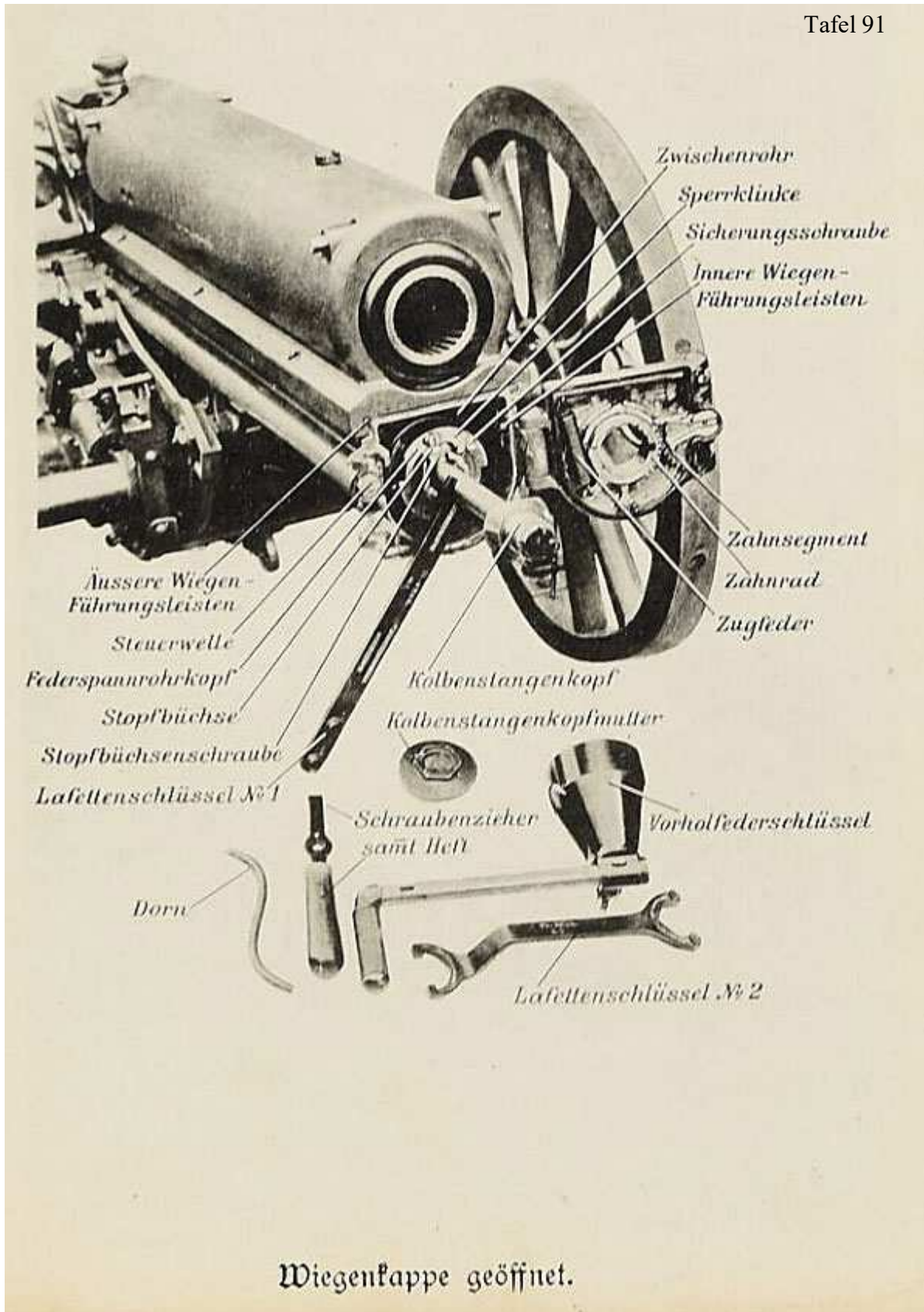

Wiegenkappe geöffnet.

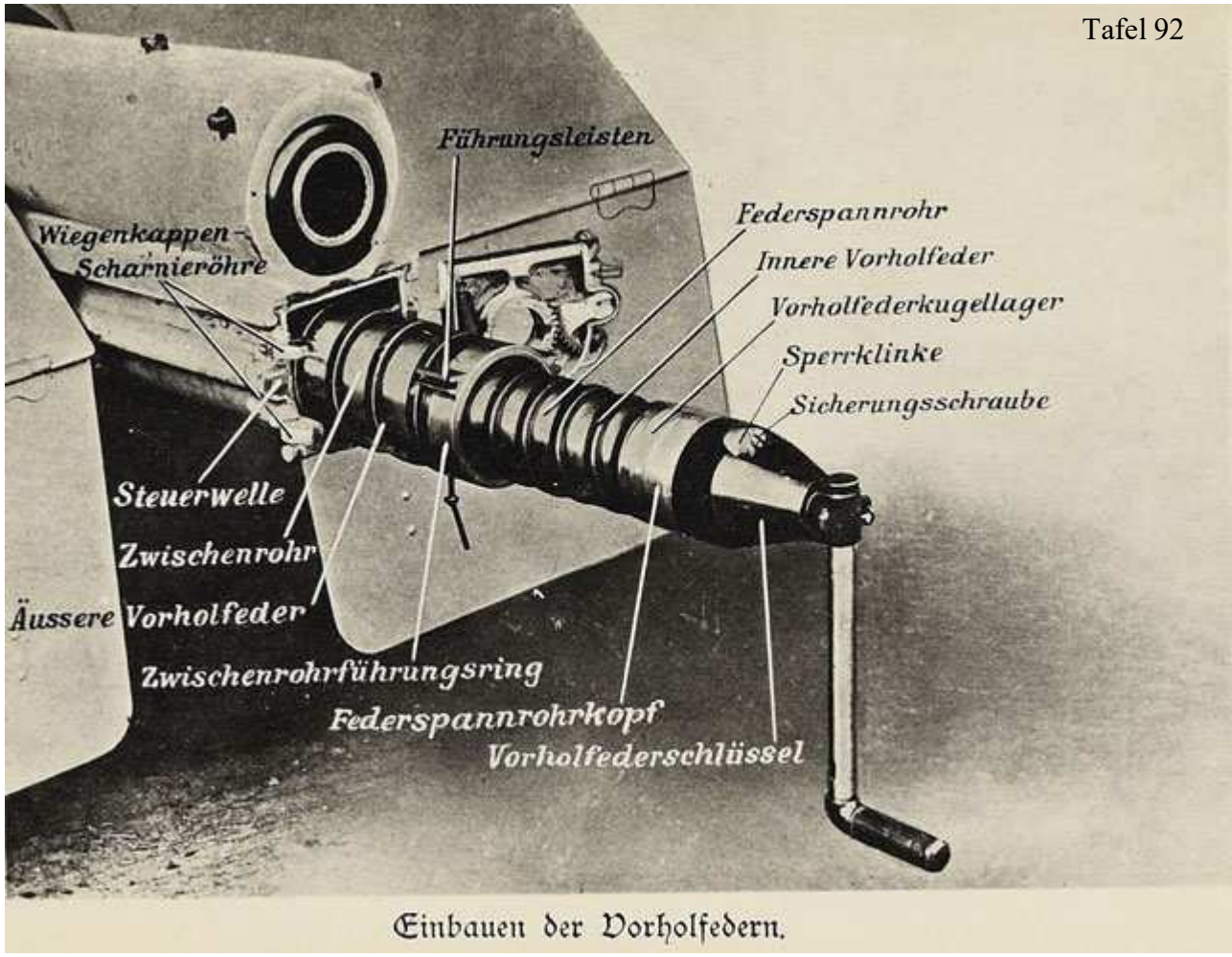

Einbauen der Vorholfedern.

# Verschluss

Tafel 93

FIG. 1.

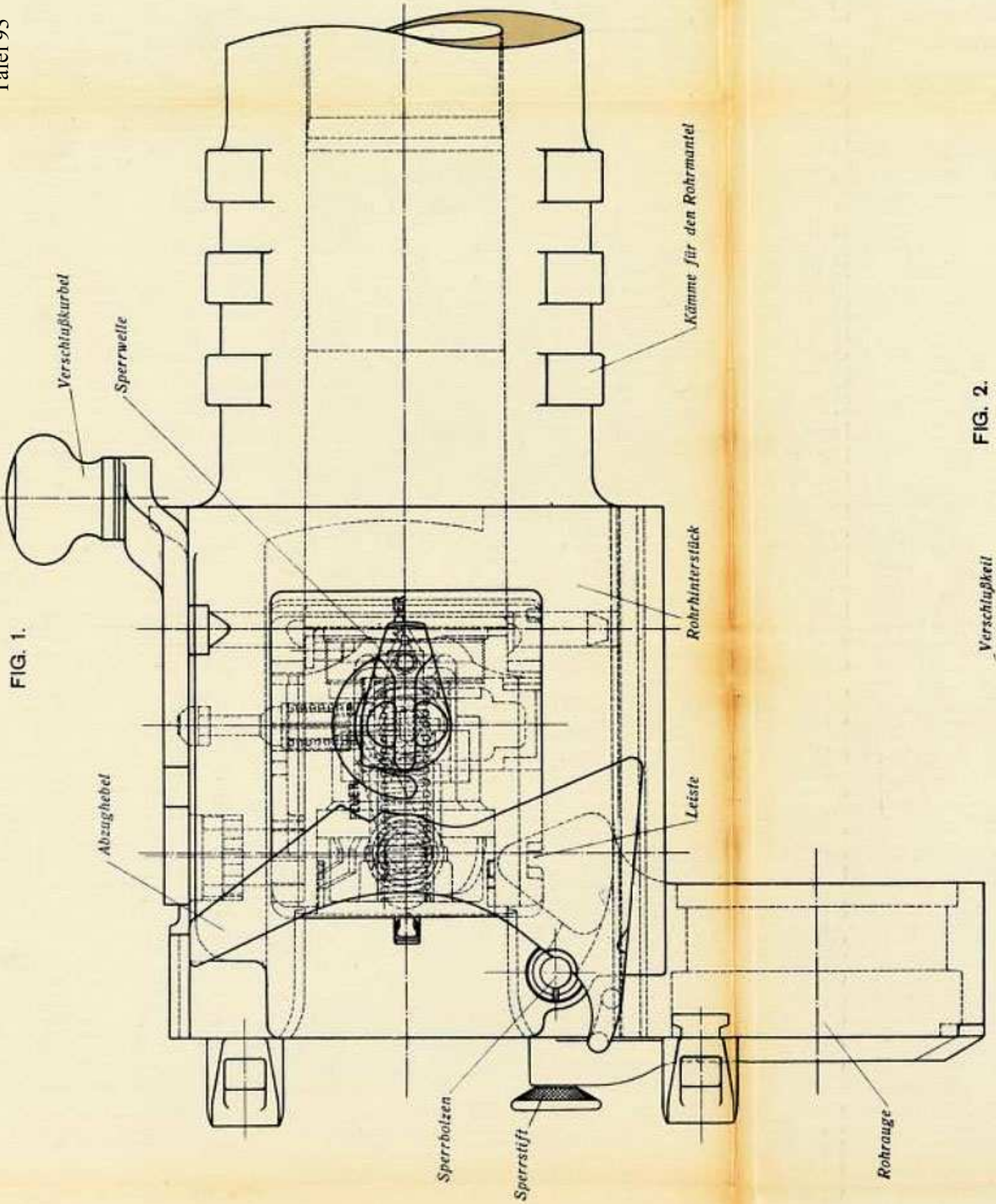

FIG. 2.

Verschlußkell

FIG. 2.

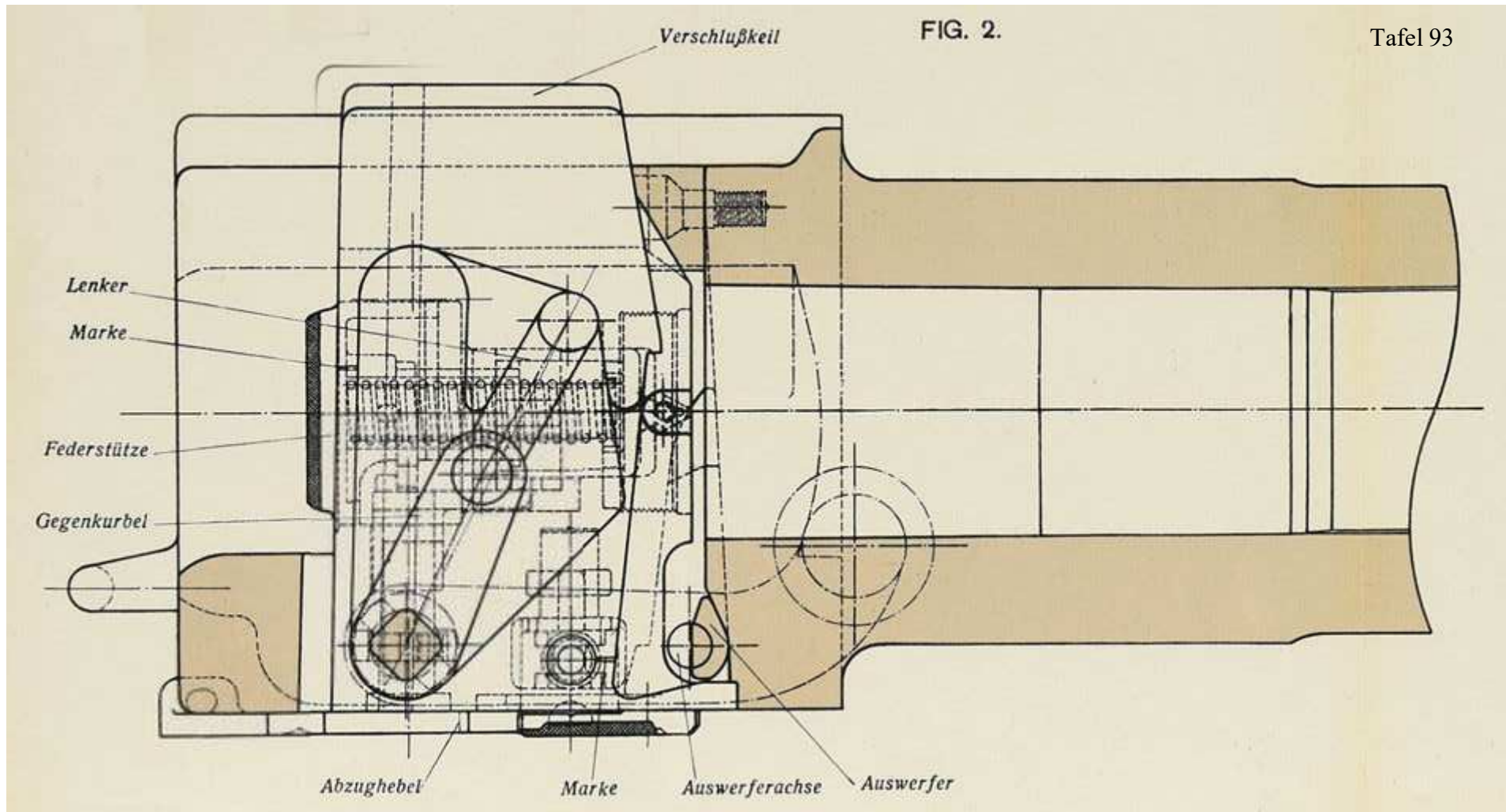

FIG. 3.

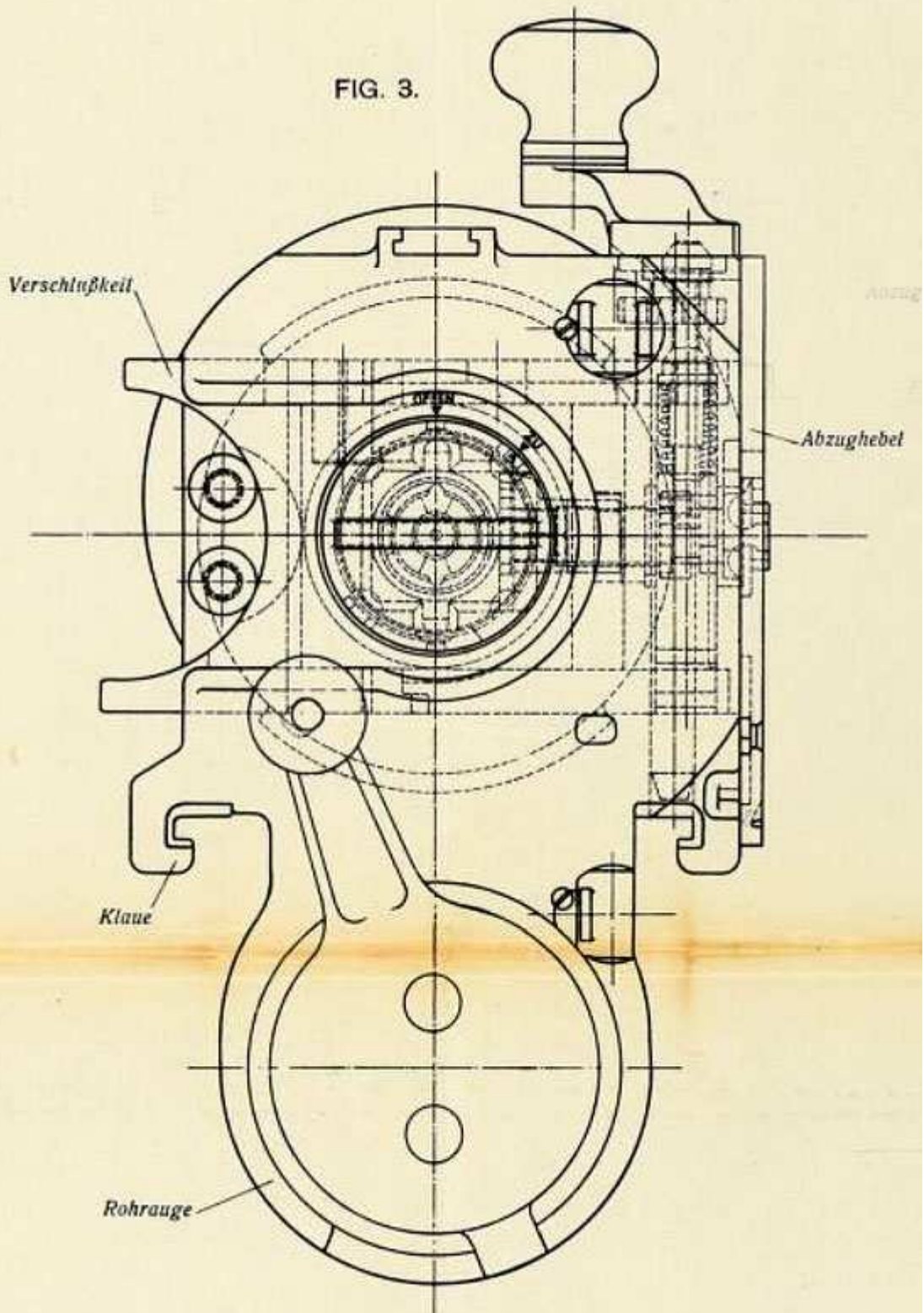

FIG. 4.

SPANNABZUG IN GRUNDSTELLUNG.

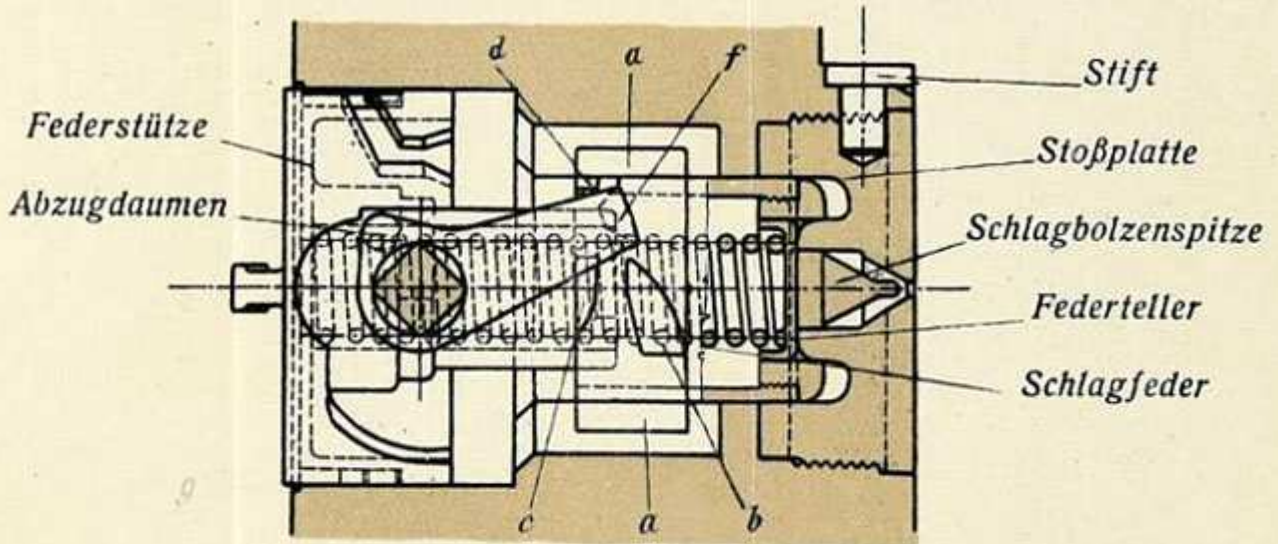

FIG. 5.

SCHLAGBOLZENFEDER GESPANNT.

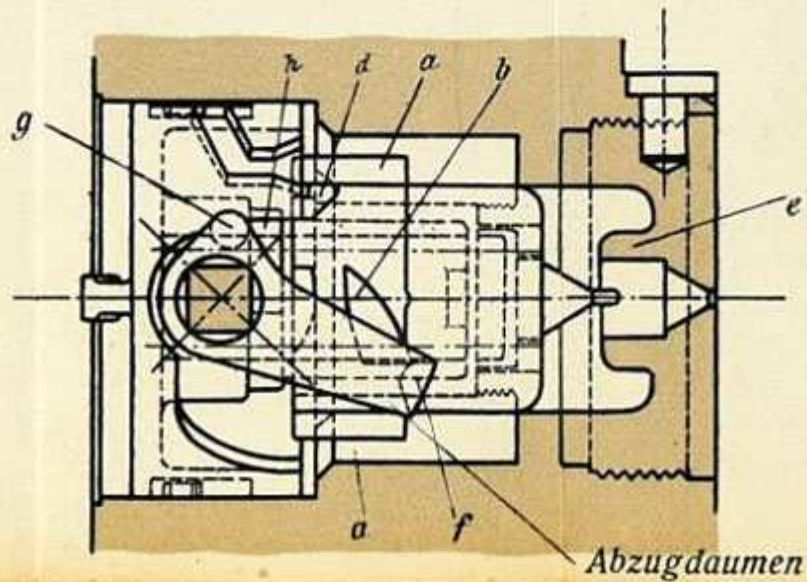

FIG. 6.



FIG. 6.

SCHLAGBOLZEN ABGEFEUERT.

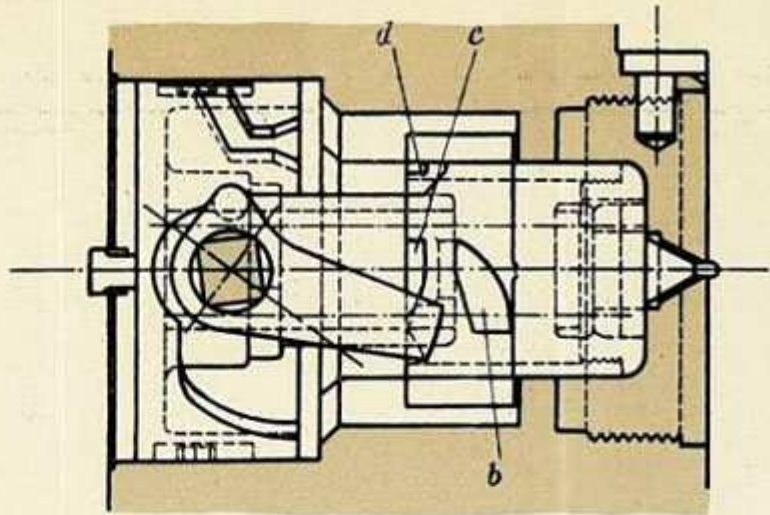
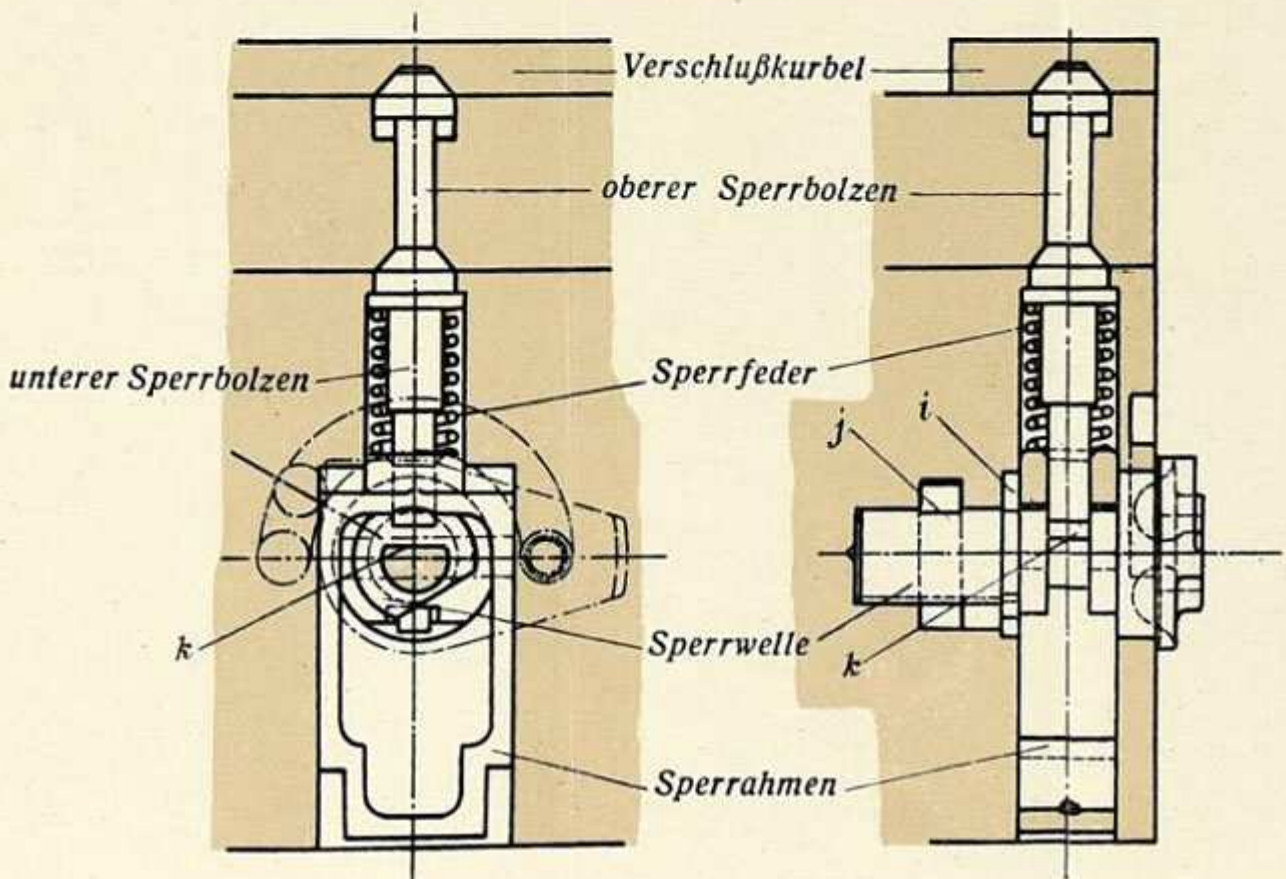

FIG. 7.

FIG. 8.

VERSCHLUSSPERRE.



ROHR UND WIEGE.

FIG. 1.

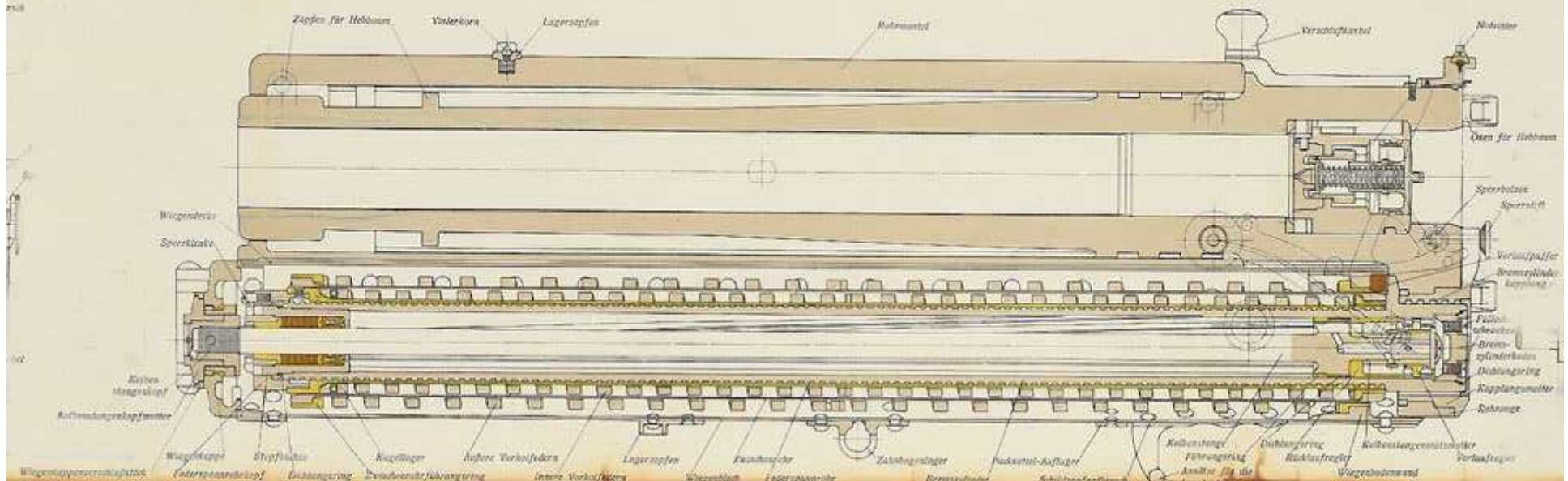

ANSICHT VON RÜCKWÄRTS.

FIG. 2.

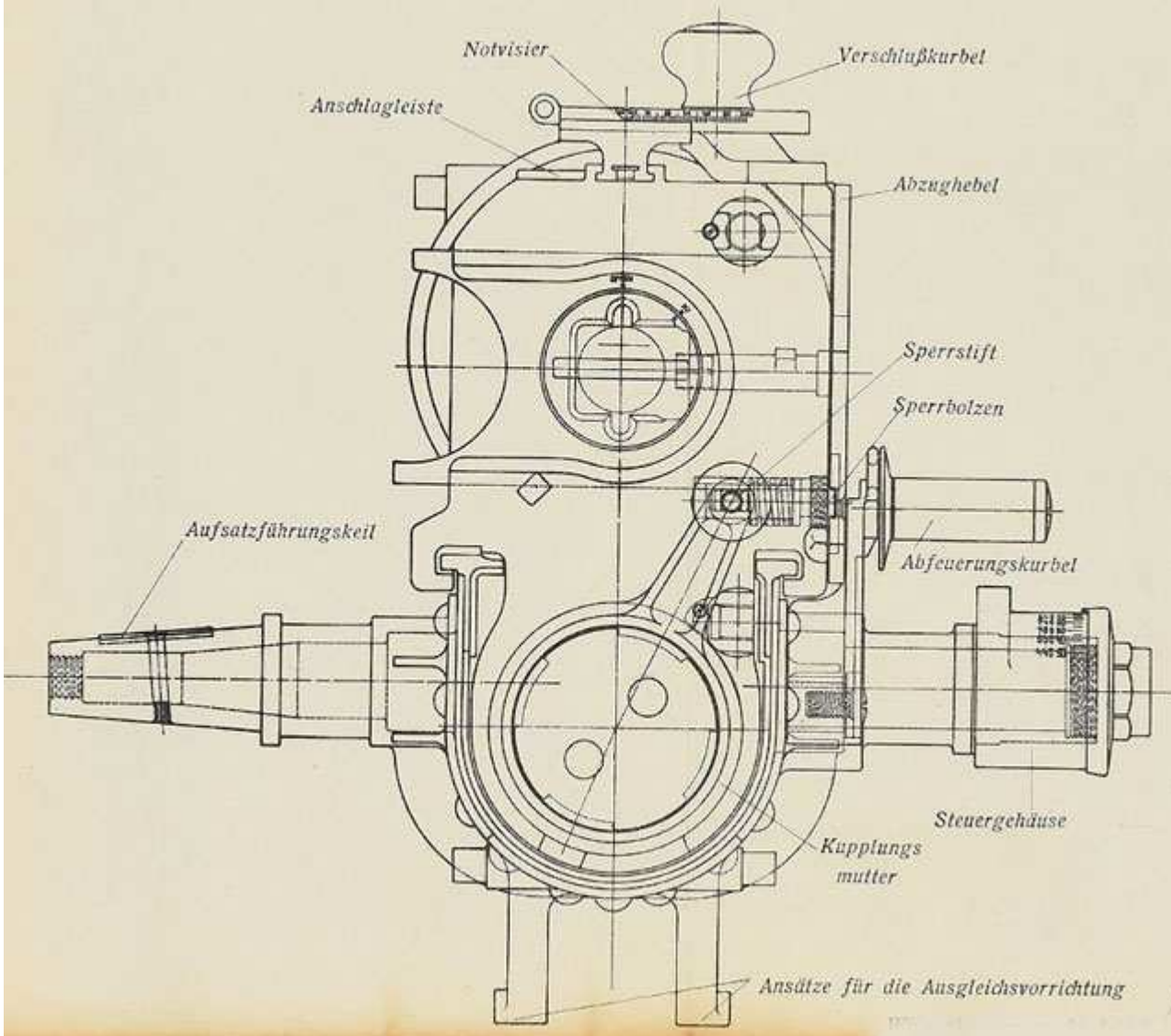

ANSICHT VON VORNE.

FIG. 3.

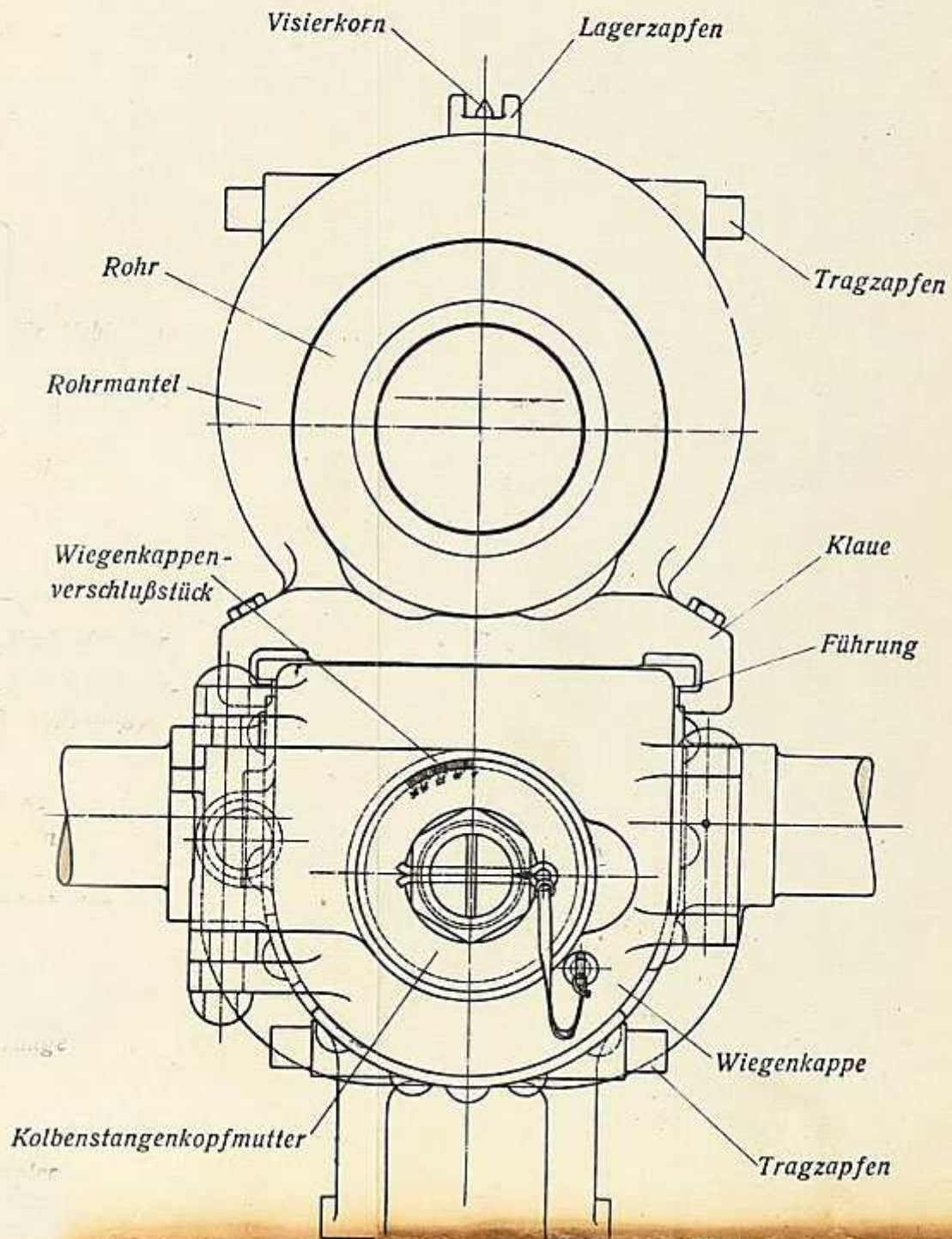
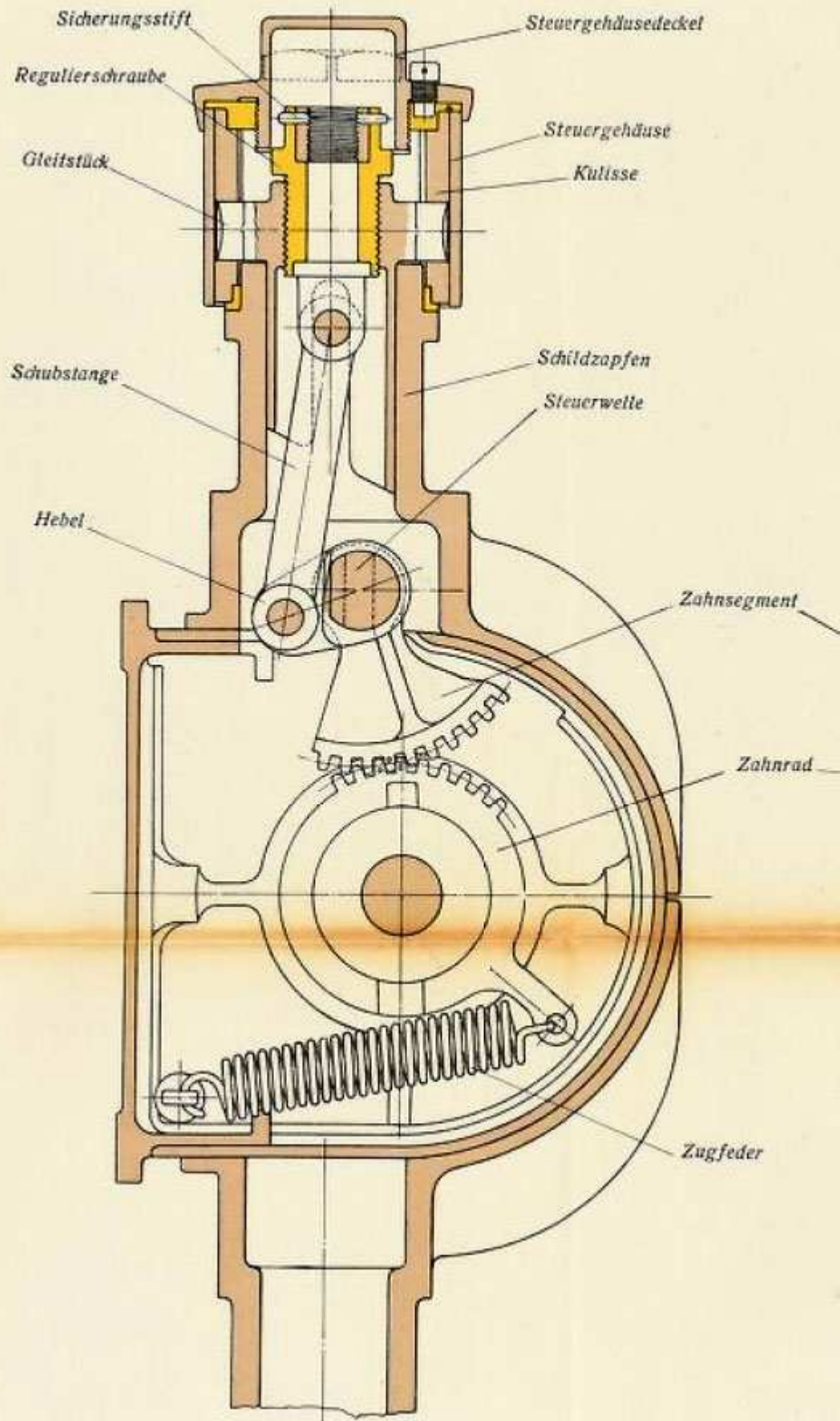
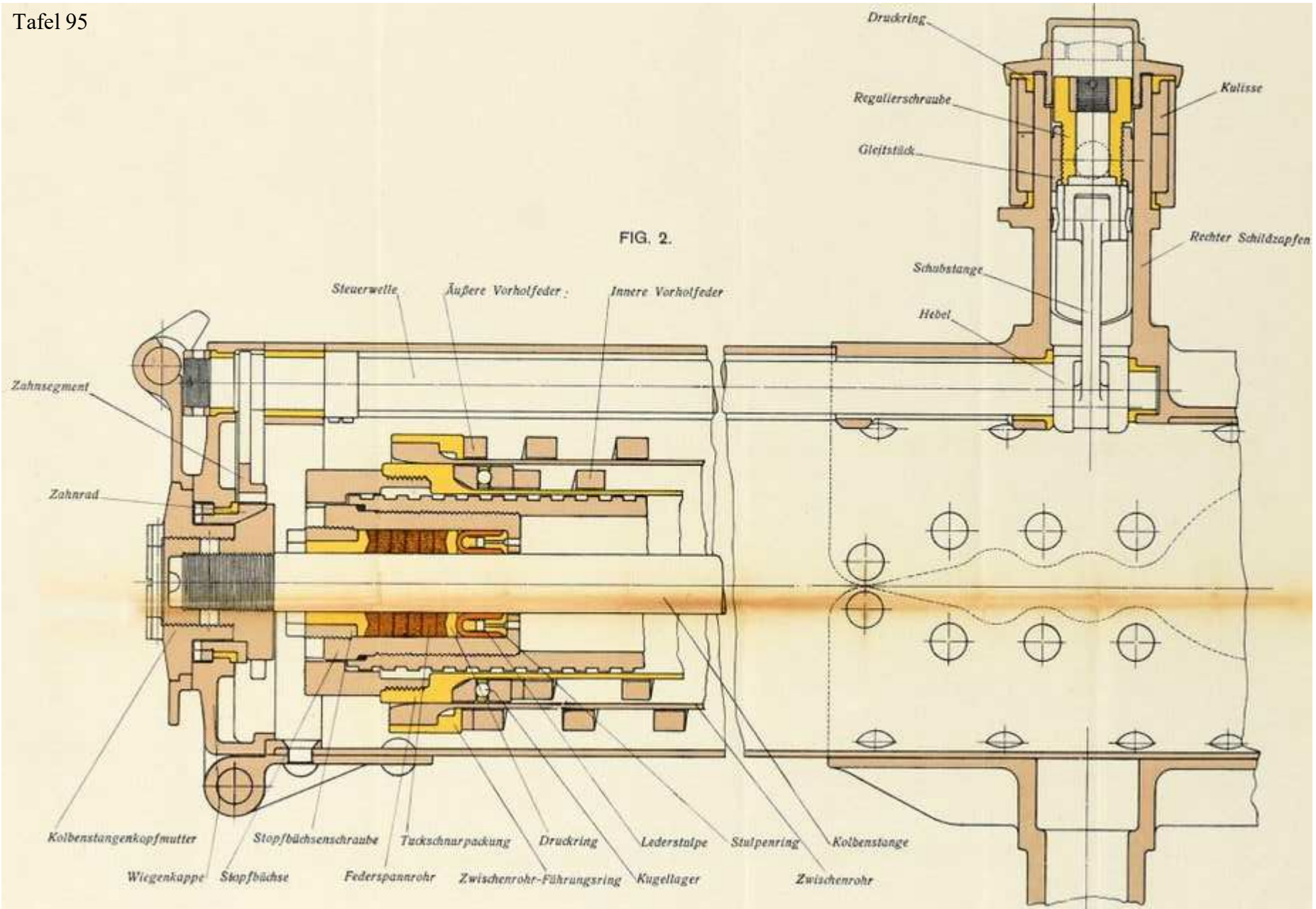

FIG. 1.





BEGINN DES RÜCKLAUFES.

FIG. 1.

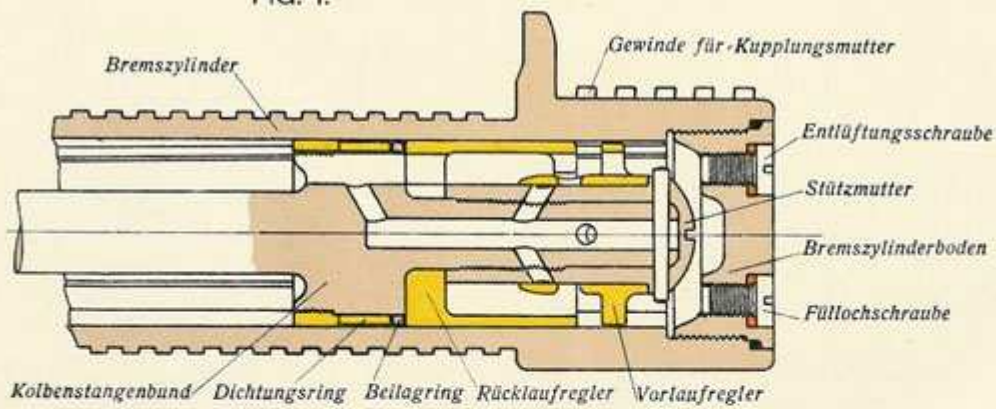

BEGINN DES VORLAUFES.

FIG. 2.

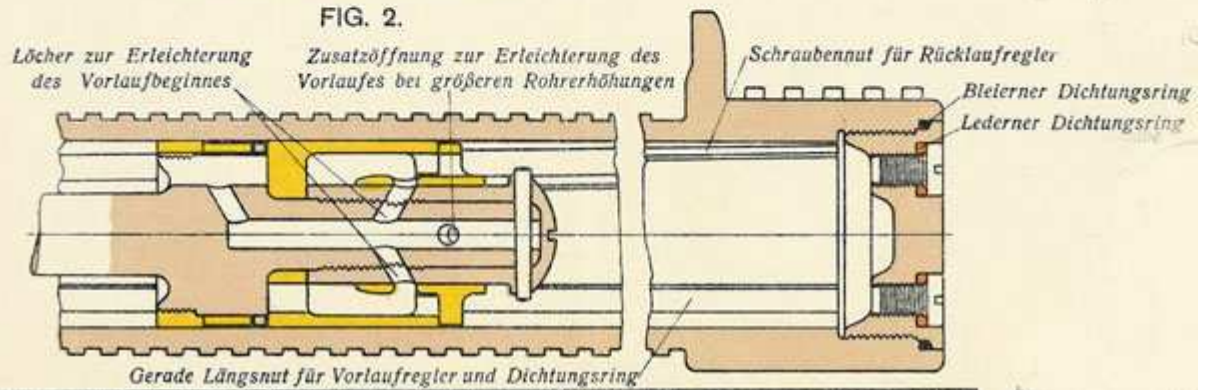

BEGINN DES RÜCKLAUFES. ENDE DES VORLAUFES.

FIG. 3.

FIG. 4.

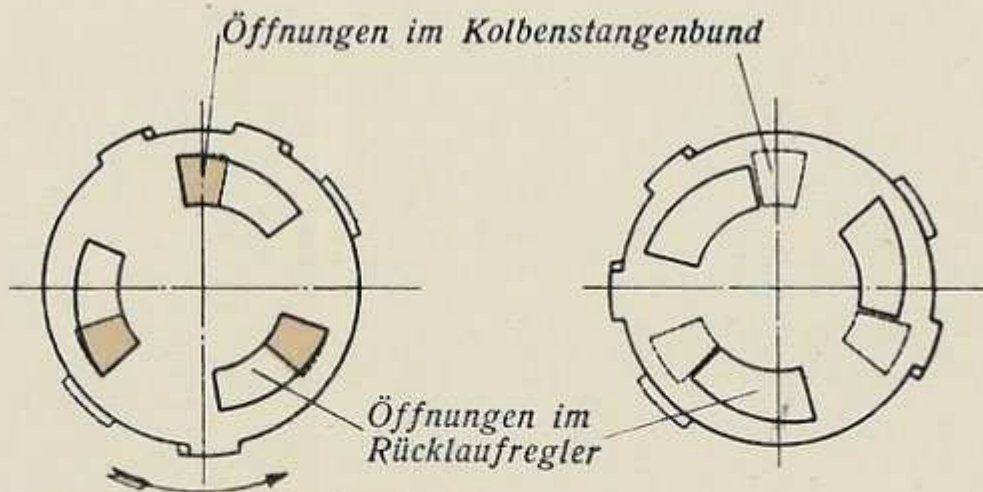

*Drehrichtung des Rücklaufreglers  
beim Rücklauf (von vorne gesehen)*

BEGINN DES VORLAUFES. ENDE DES VORLAUFES.

FIG. 5.

FIG. 6.

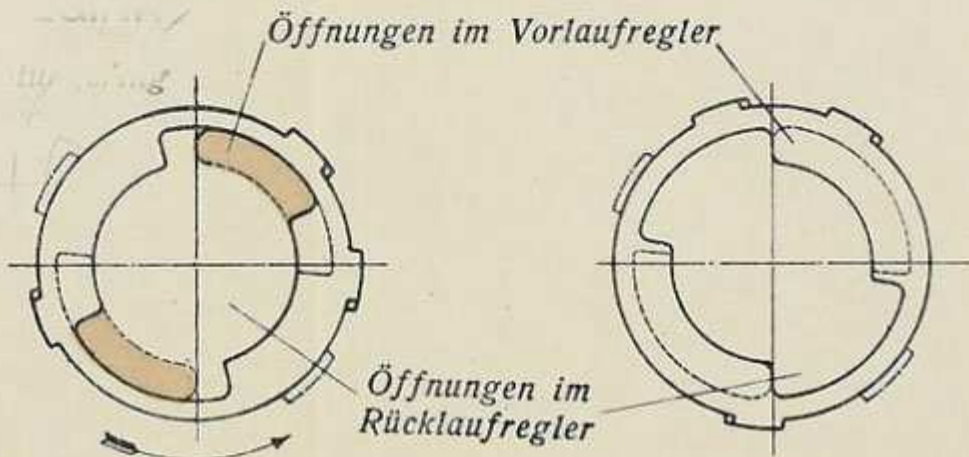

*Drehrichtung des Rücklaufreglers  
beim Vorlauf (von rückwärts gesehen)*



# Schema des Batterierichtkreises

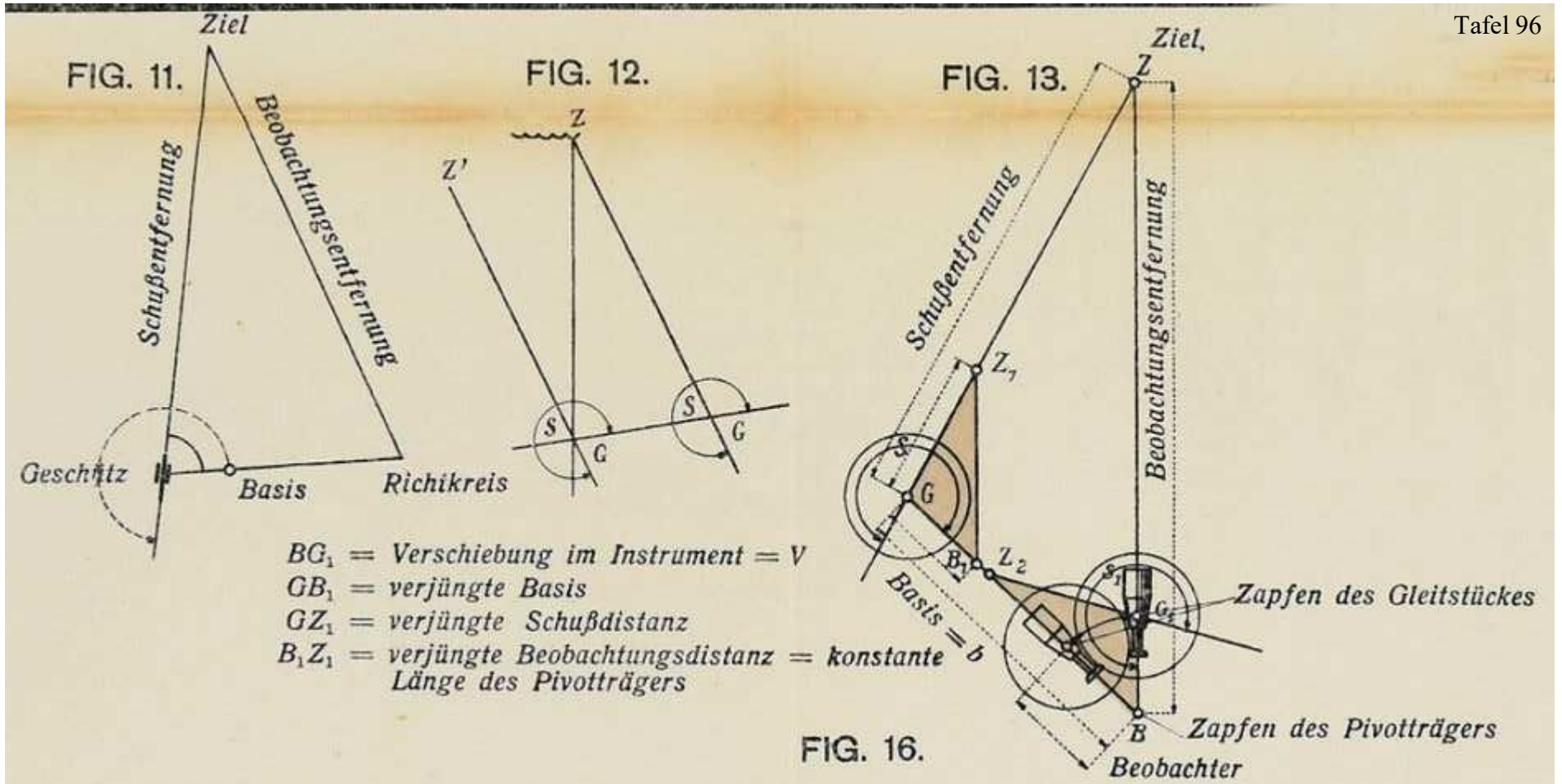

FIG. 14.

Scheinbare Länge des 2 m  
Stabes in Strichen = 7

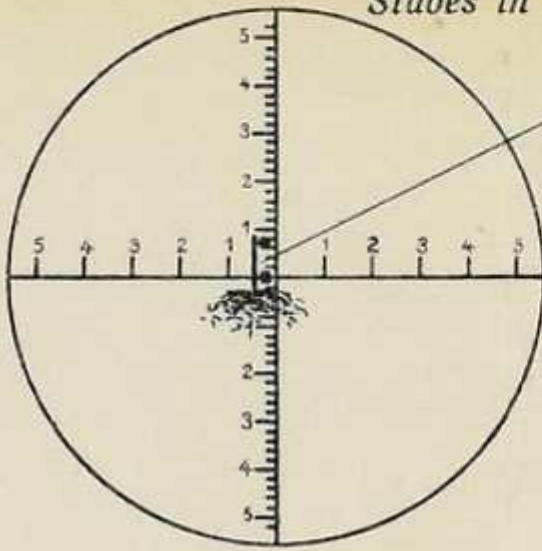
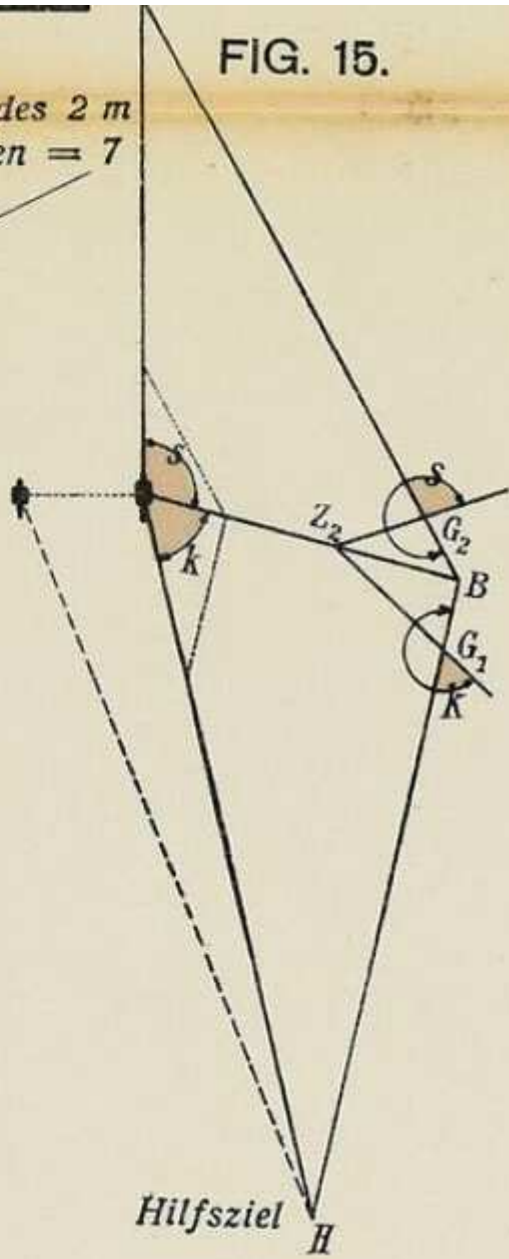
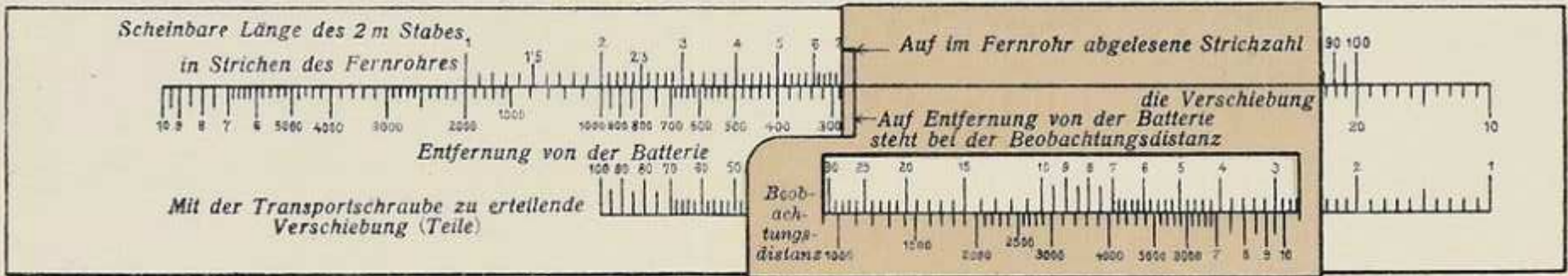

FIG. 15.





Tafel 96

FIG. 17.



# Schema des Aufsatzes

FIG. 7.

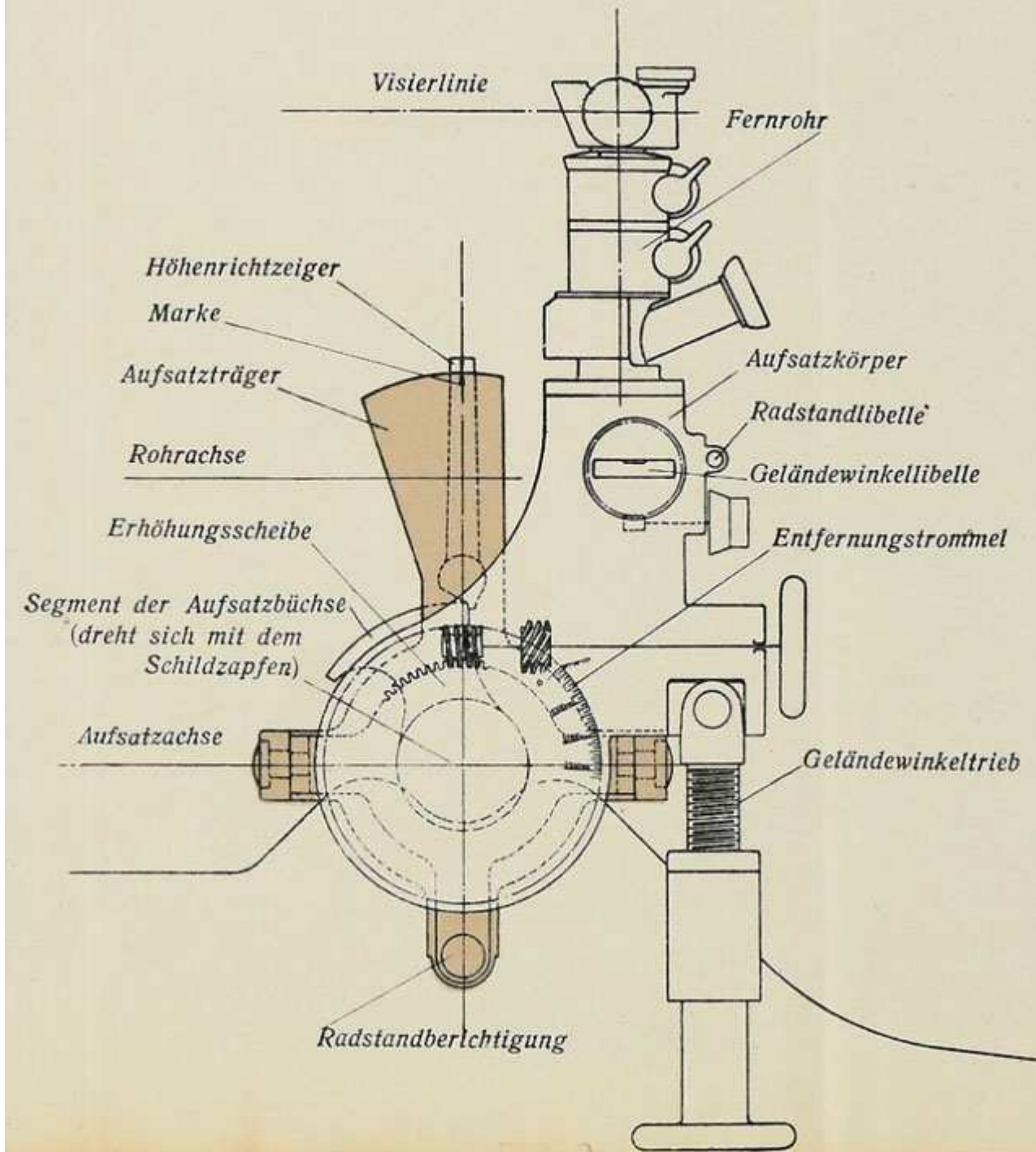

FIG. 8.

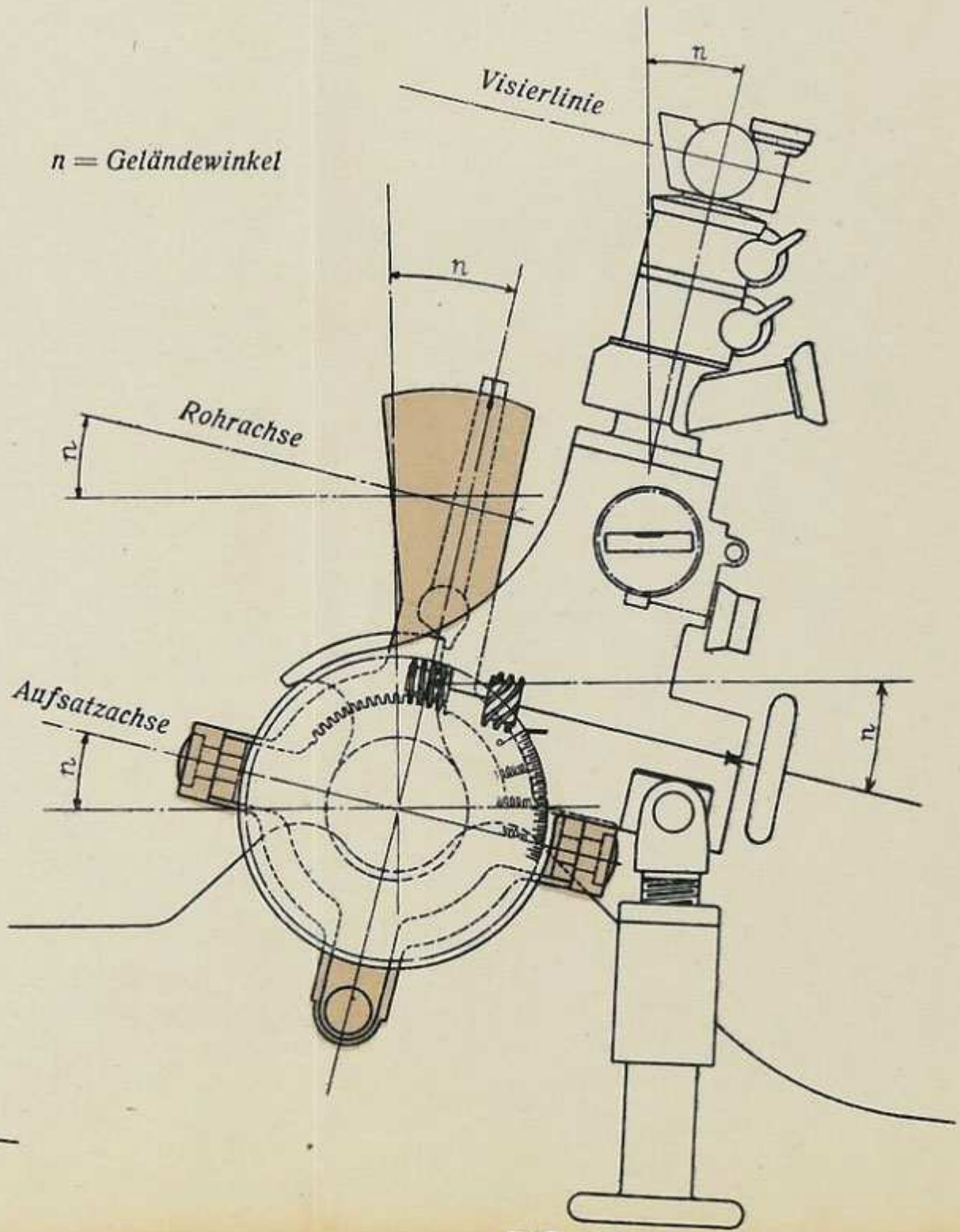

FIG. 9.

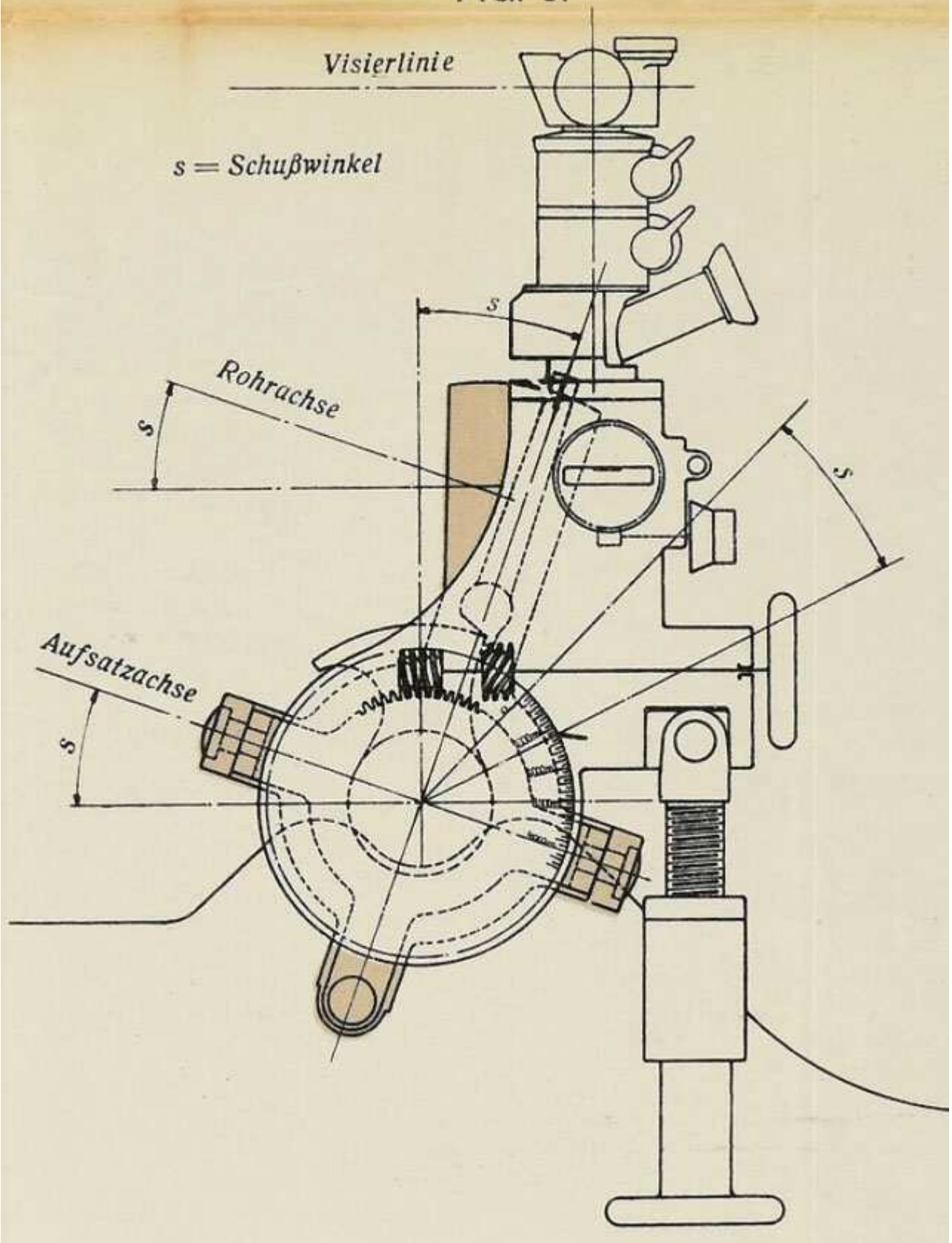
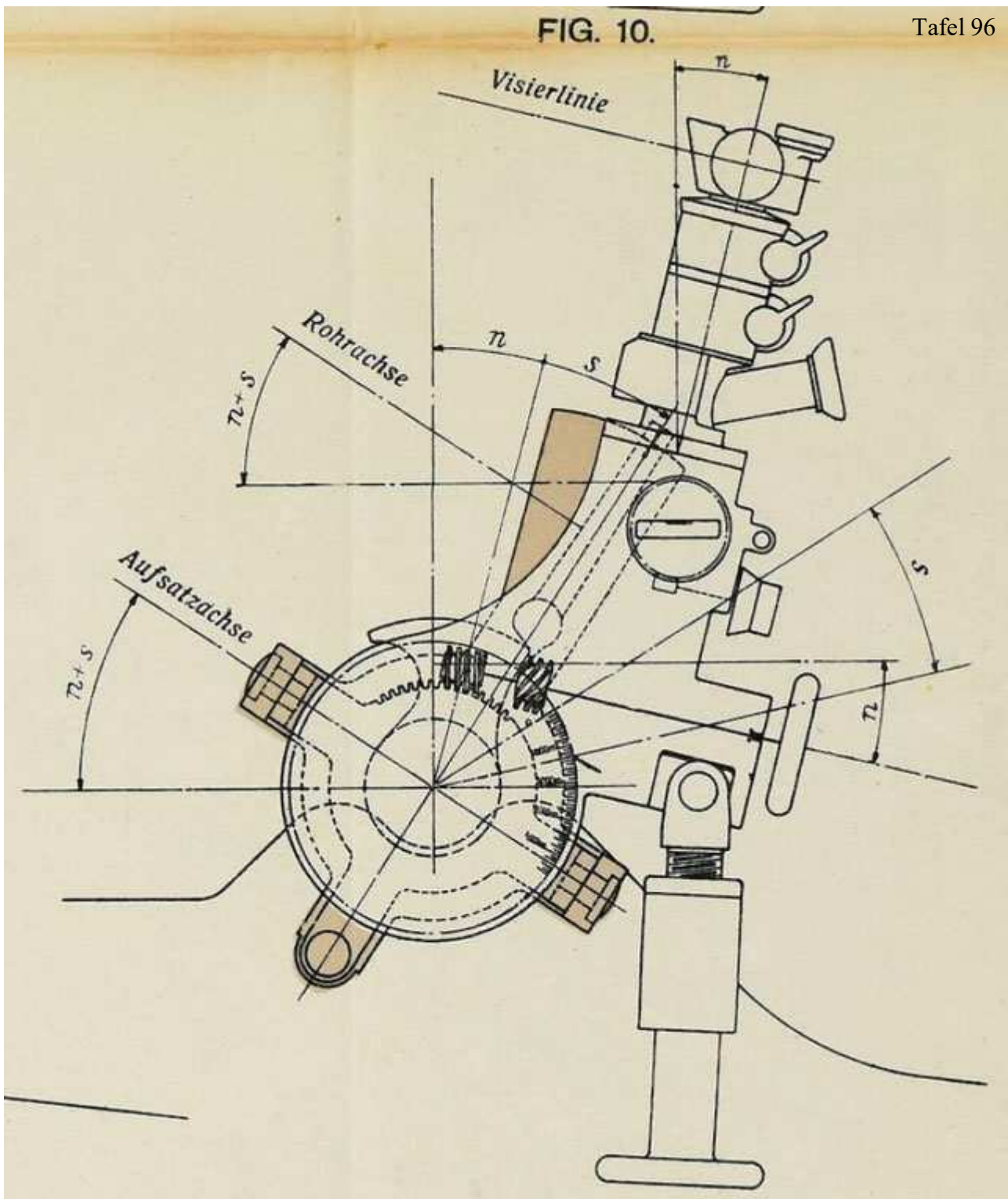
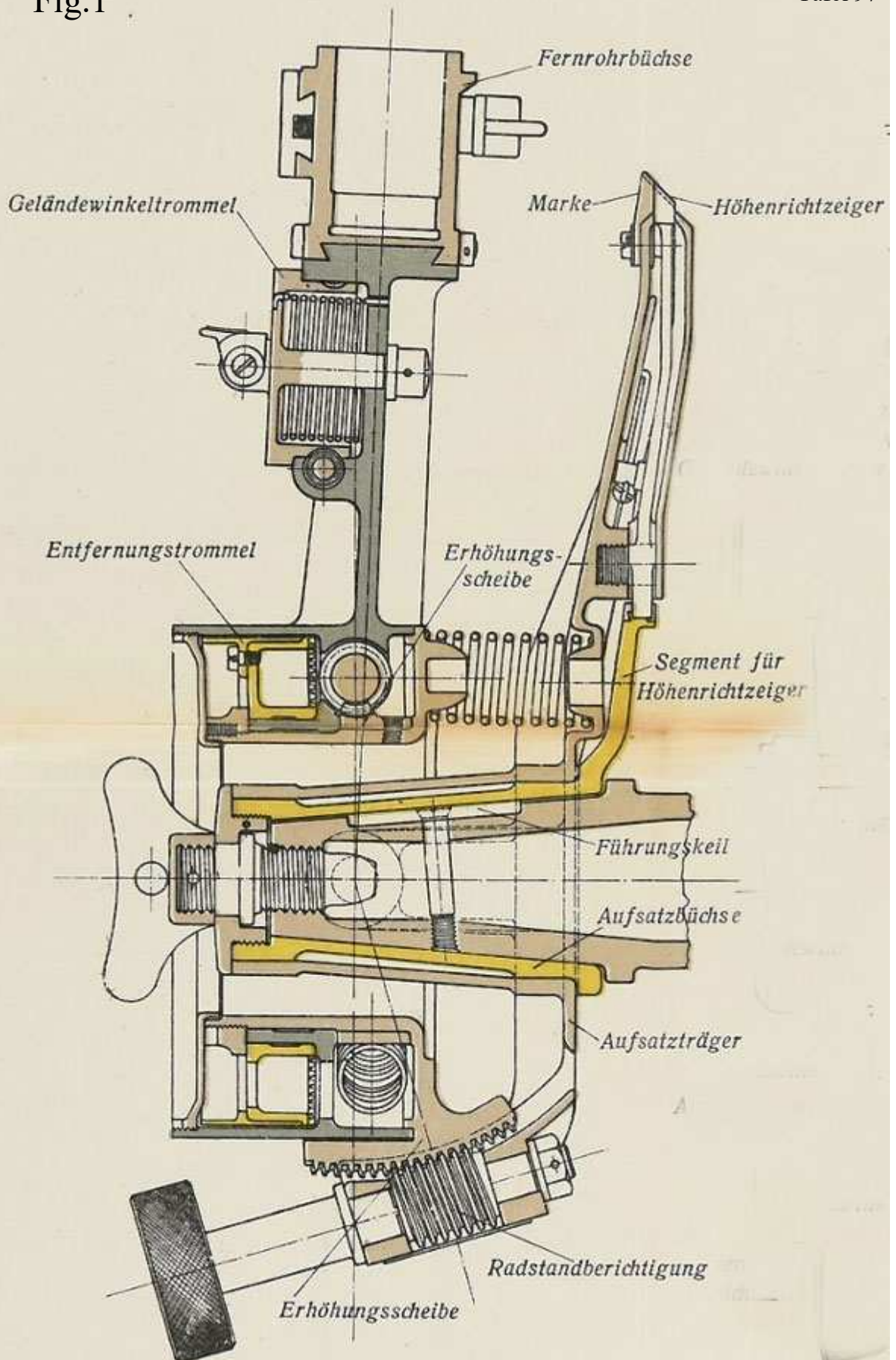

FIG. 10.



# Aufsatz

Fig.1





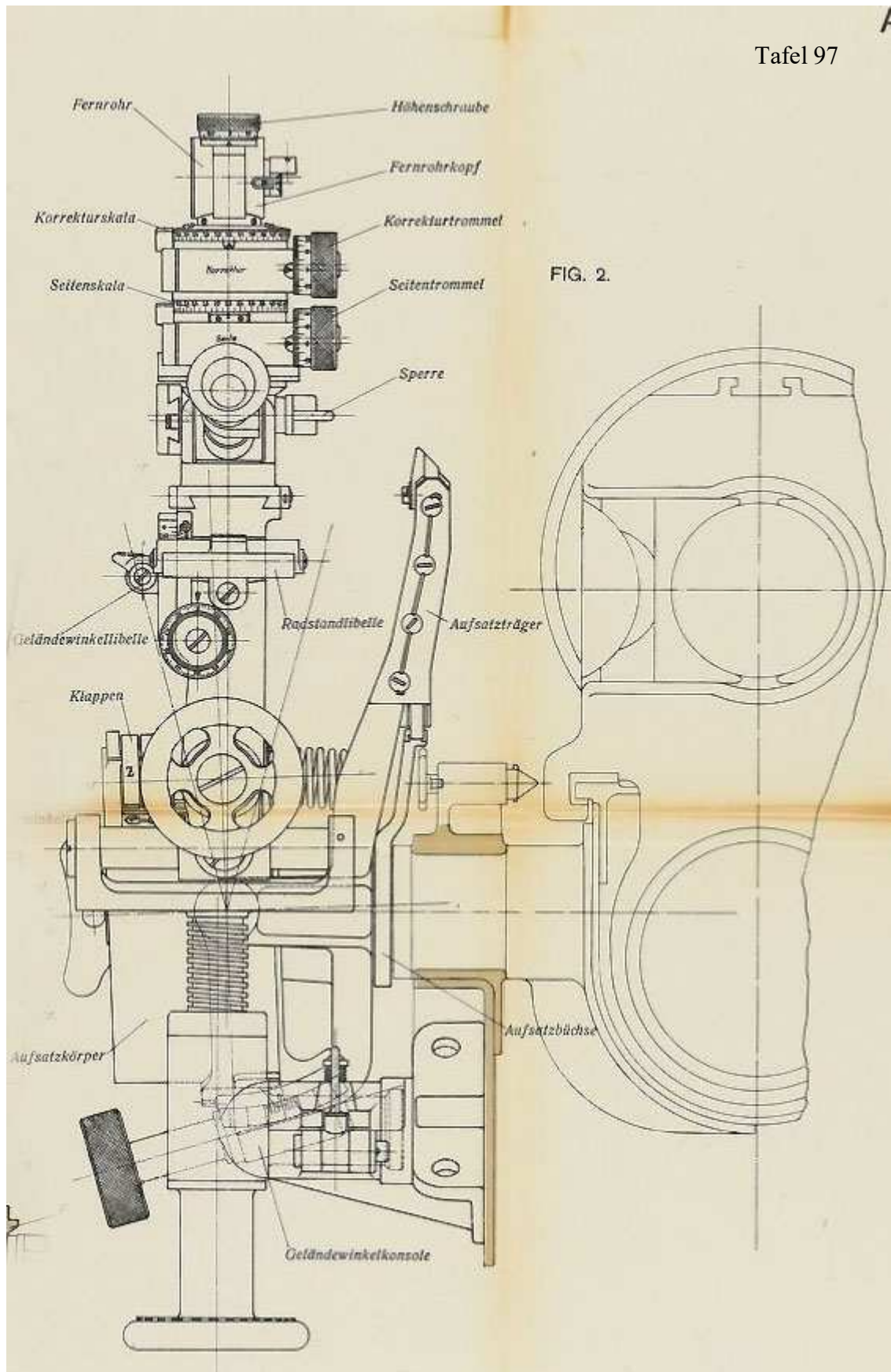
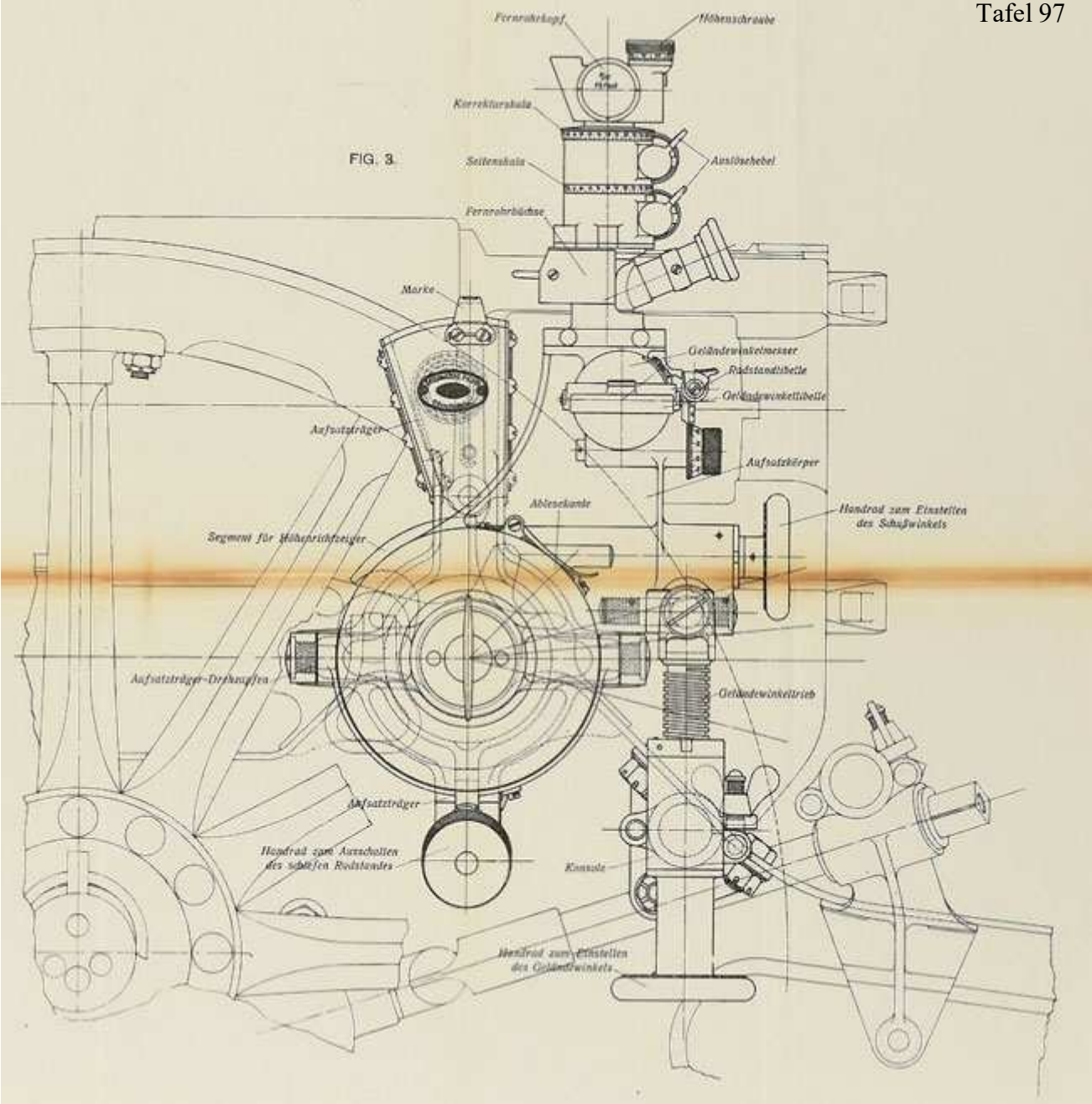
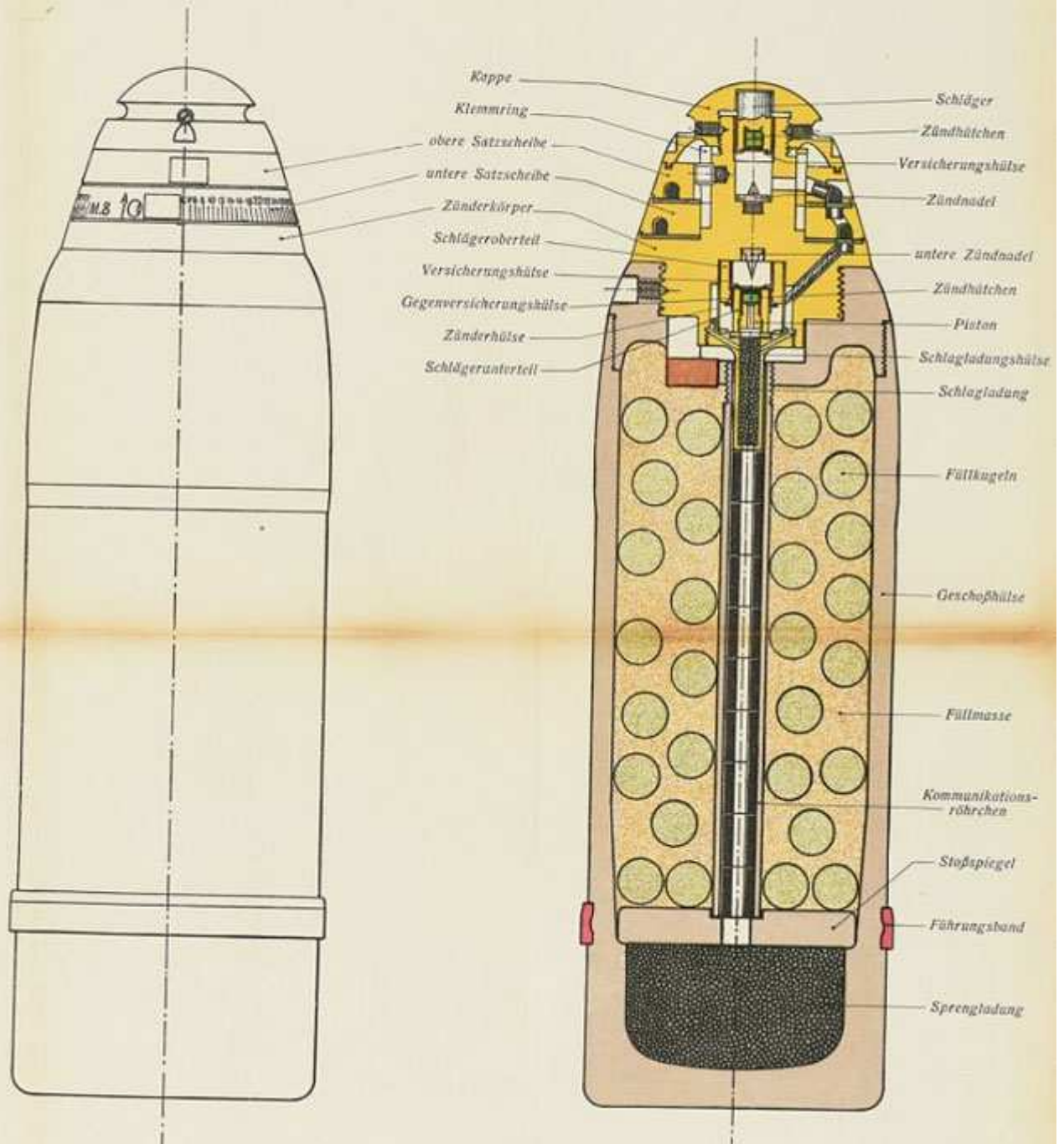

FIG. 3.



## 7.5cm M. 15/8 SCHRAPNEL.



7.5 cm M. 15/15a GRANATE.

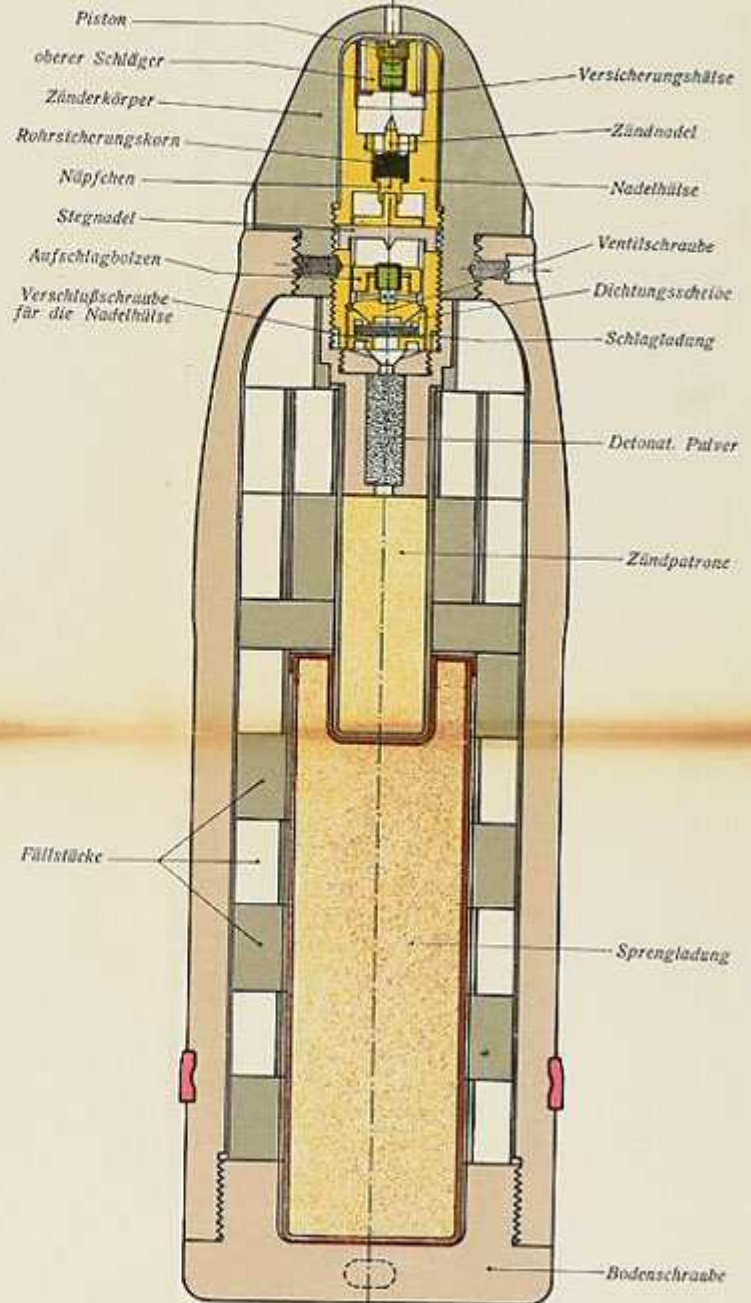
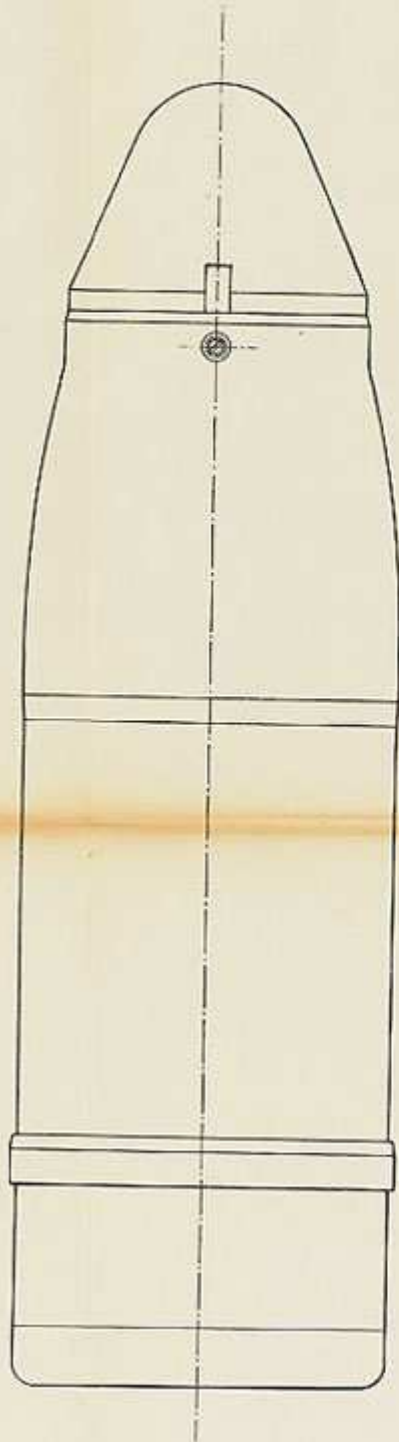

# 7.5 cm M.15 Patronenhülse

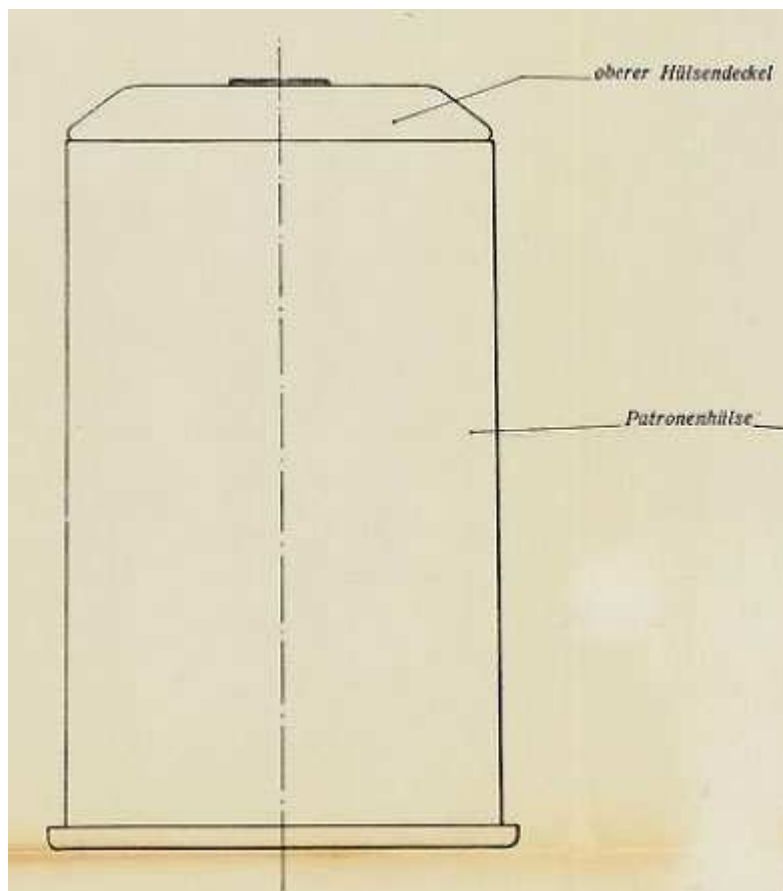

Tafel 100

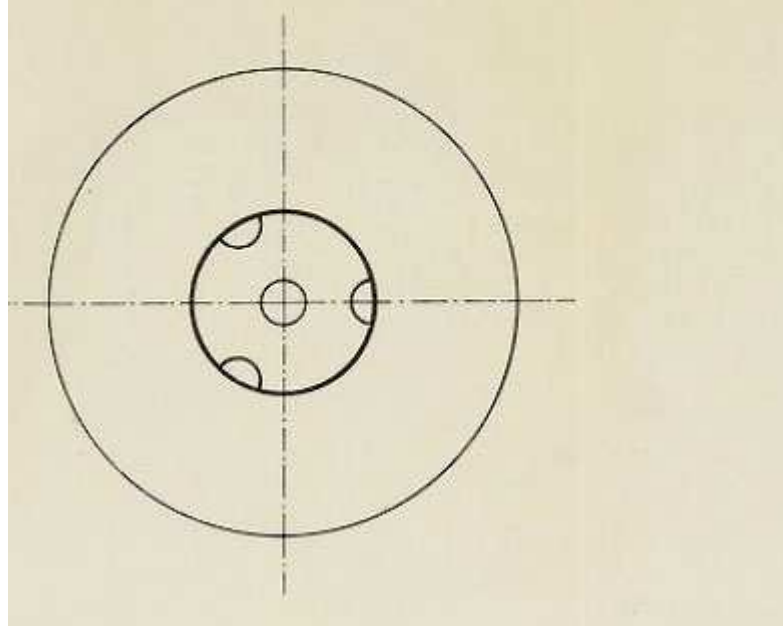

Tafel 100

